

User Manual

Calibration Software

PTC04 Programmer

Introduction

In this document you'll find a description of:

- The Calibration Setup.
- How to proceed with the calibration check.
- What if the calibration check fails?
- How does the calibration work?
- What do we calibrate?

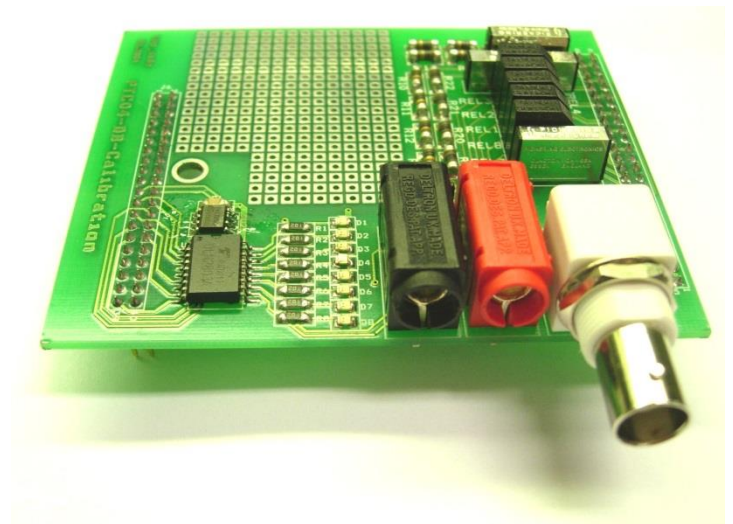

Figure 1: PTC04-DB-Calib.

Contents

Introduction	1
Contents	2
Calibration Setup	3
Requirements	3
Connections	3
RS232 settings	4
TCP/IP settings.....	4
Check Calibration of the programmer	5
Calibration check	6
Before starting the calibration check	6
Manual voltmeter.....	9
The calibration check	10
There are three possible outcomes.....	10
What if the Calibration check failed	12
Check Calibration Setup	13
Measurement failed	13
Large deviation	14
Loggings	15
Calibration details	15
How does the calibration work?.....	15
ADC.....	15
DAC.....	16
What do we calibrate?	17
Sensing lines:	17
PPS1:.....	17
PPS2:.....	17
PPS3:.....	17
PPS4:.....	17
Contact	18
Disclaimer	18

Calibration Setup

Requirements

For the calibration test you need:

- A high accuracy voltmeter;
- A PTC04 calibration board (PTC04-DB-Calib Supporting daughter board for calibration of PTC04 programmer).

The software has an automatic calibration feature. For this you need a Keithley 2000, Agilent (HP) 34401A or an KEYSIGHT 34461A multimeter. The Agilent 34401A multimeter is supported in the PTC04 User Interface revision 1.35 or higher. If you use the automatic calibration feature, all channels will be calibrated with the multimeter as reference meter.

If a manual approach is used, only the first sensing line is calibrated with the external reference meter. For all the other channels the first sensing line will be used as reference.

IMPORTANT NOTE:

Although the firmware version of the PTC04 has no impact on the quality of the PTC04 calibration, it is advised to upload the `ptc04_mlx90251_firmware.hex` or `ptc04_mlx90316_firmware.hex` firmware to the PTC04 **before** replacing the daughter board of the PTC04 with the PTC04-DB-Calibration.

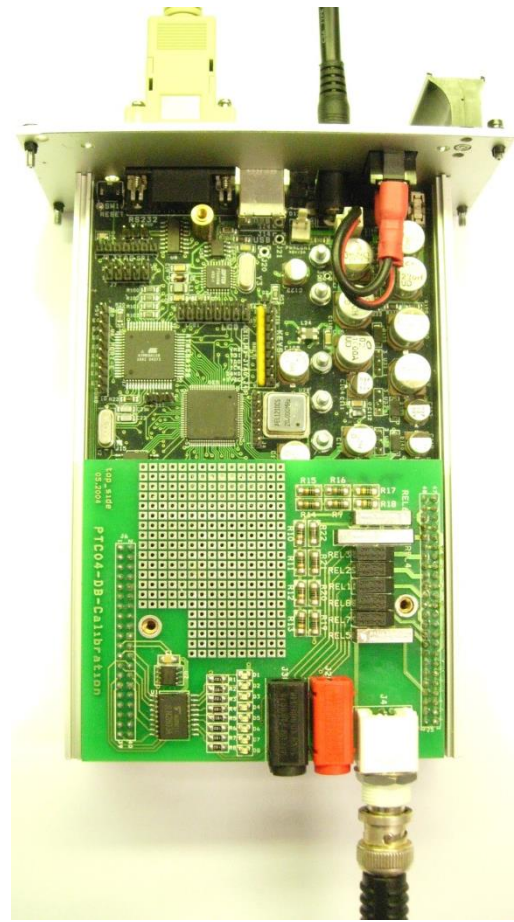
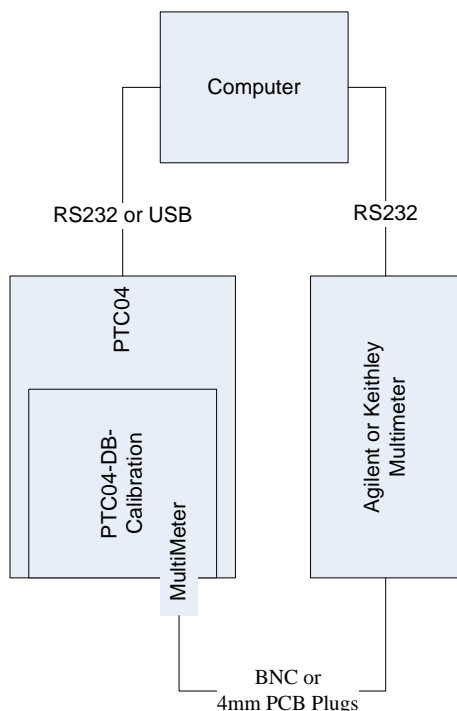

Figure 2: Connections



Because: some firmware versions have a pre-configuration of the relays on the daughter board that does not match with the relay configuration of the PTC04-DB-Calibration.

Connections

1. Replace the daughter board of the PTC04 with the calibration board:
 - Remove the cover of the PTC-04;
 - Remove the PTC04 Daughter Board of the MLX device;
 - Plug in the PTC04 Calibration Board;
2. Connect the reference voltmeter to the BNC connector **or** 4mm PCB Plugs (Both connections are in parallel);
3. Connect the RS232 or USB cable to the PTC04 and the PC;
4. Connect the RS232 of the multimeter to the PC;
5. Connect the power supply of the PTC04.

Figure 3: PC Connections

RS232 settings

The RS232 communication of the multimeter has to be configured as follows:

Keithley 2000 multimeter

BAUD: 19.2 K
FLOW: NONE
TX TERM: CR

Agilent (HP) 34401A multimeter

BAUD: 9600
PARITY: EVEN: 7BITS **OR** PARITY: NONE: 8BITS
LANGUAGE: SCPI LANGUAGE: SCPI

For configuration instructions, please consult the user's manual of your multimeter.
All other settings are set by the software via RS232 commands.

TCP/IP settings

Modern meters will not support a RS232 port anymore, instead you can use the Ethernet port. Just connected the multimeter with the PC through an ethernet cable. It is recommended to connect the multimeter directly to the PC, if this is not possible you can connect to your Local network but make sure both devices are connected to the same network.

When you selected a multimeter that supports TCP/IP you need to enter the IP-address of the meter.

It can be found at:

KEYSIGHT 34461A multimeter

Utility -> I/O config -> LAN settings

Fill in the IP-address in the provided Edit-box.

Check Calibration of the programmer

Now your PTC programmer is connected and you can **start-up the MPT software**.
When the software is started, double click on **PTC-04** in the UI modules list
or select from the menu “Tools → Search devices → All”

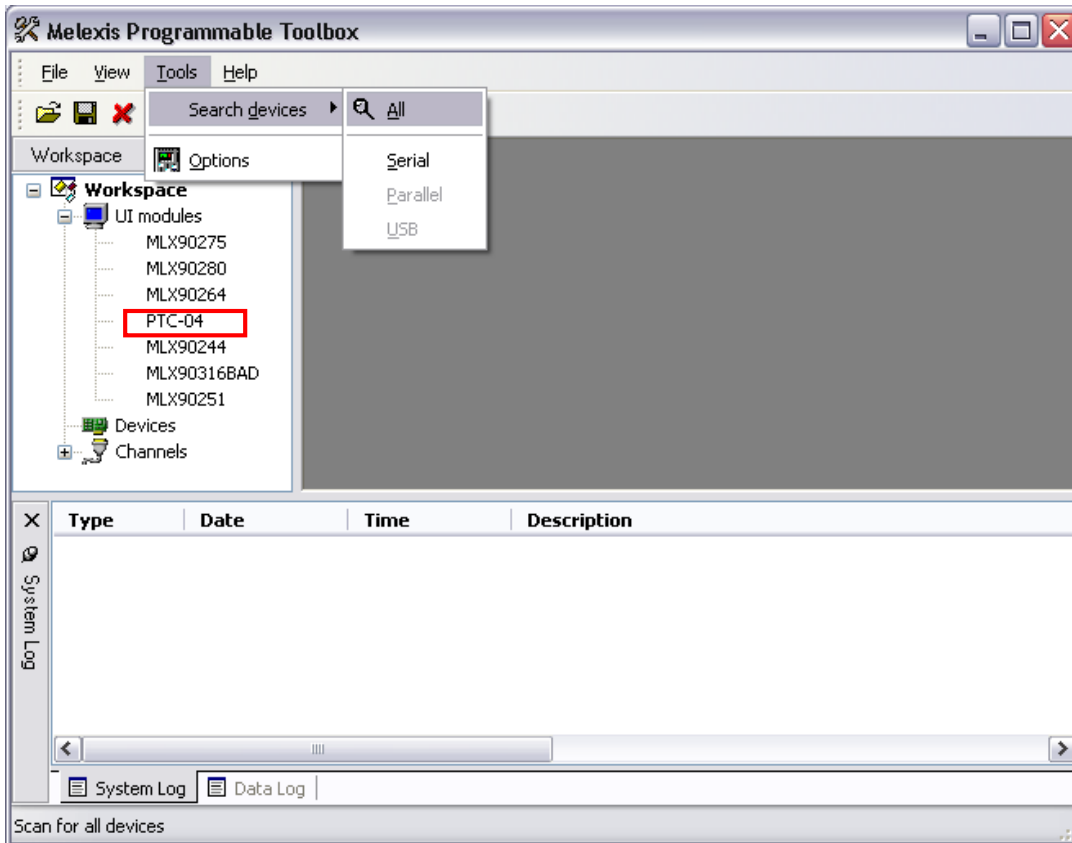
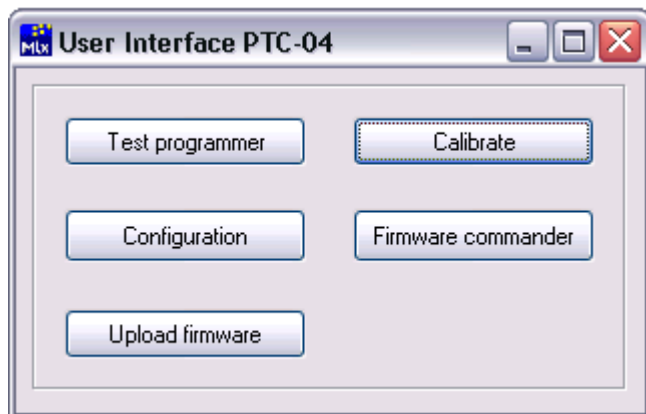

Figure 4: Melexis Programmable Toolbox.

The software will search for all available devices. When a PTC programmer is found it will be initialized. Otherwise the software will display a notification that no PTC devices have been found and will enter the disconnected state.



If the connection failed, check the serial cable and power connection or change the settings if you have connected the programmer to a different serial port.

To open the Calibration test module, press the button **Calibrate** on the PTC04 User Interface.

Figure 5: User Interface PTC-04.

Calibration check

This module of the PTC-04 User Interface is used to verify if the calibration parameters of the programmer are within tolerance. The software will check the power drivers (DAC) and the voltmeter (ADC), and compare its results with the calibration parameters. If the calibration parameters are out of tolerance, they **can** be corrected.

Before starting the calibration check

- It is advised to leave the programmer powered up for minimum 30 to 60 minutes before starting the calibration. For the accuracy of the calibration, it is important that the programmer is at operating temperature.
- **Very important:** do not connect any load on the connectors of the calibration board during the calibration check. Any additional load will corrupt the calibration parameters and lead to an unusable set-up. If this should happen, restart the calibrate check without a load connected to the programmer.
- If you have a Keithley 2000 or an Agilent (HP) 34401A Multimeter, select the correct multimeter from the selection box (1) before you start the calibration check. The multimeter has to be connected to the PC used for the calibration check. The default COM-port for the multimeter is COM2. One can change the selected COM-port in the "COM port #" Edit-box (2).
When selected a meter that supports TCP-IP fill in the IP-address instead.

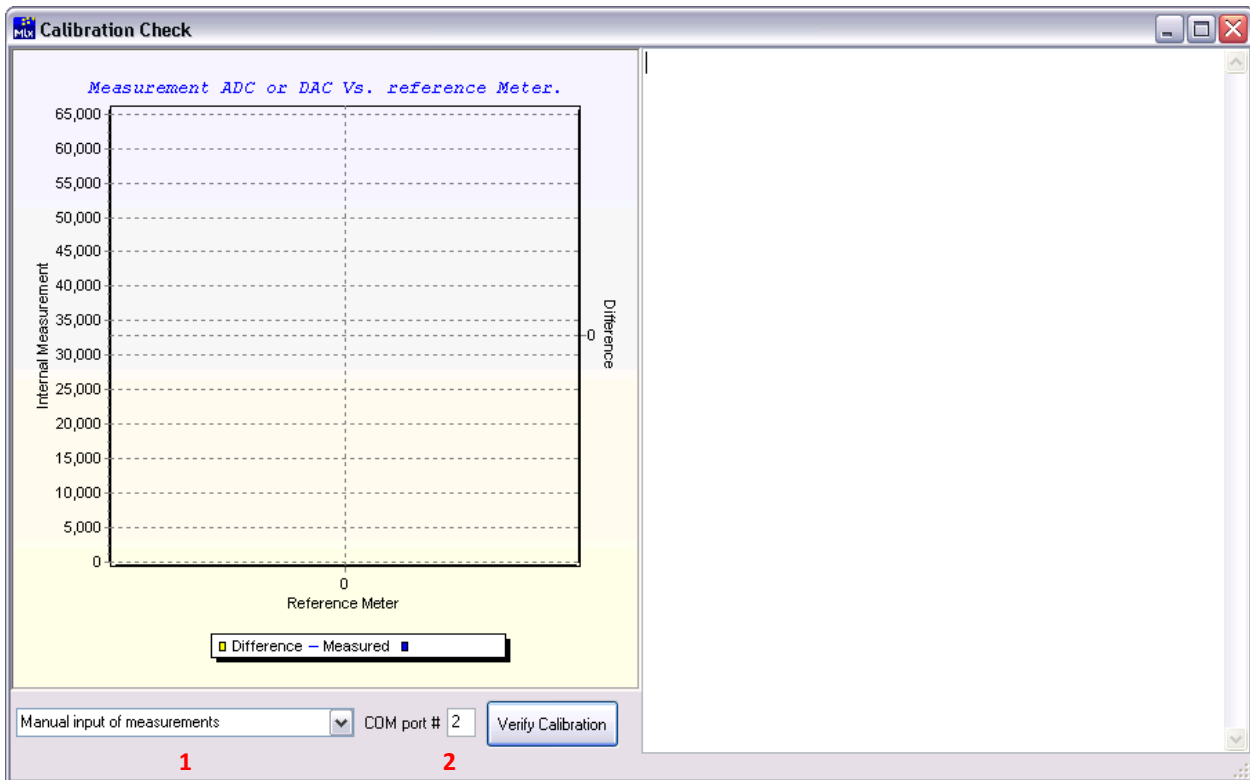

Figure 6: Calibration Check.

- Press **Verify Calibration** to start the calibration.

You are reminded to leave your PTC04 powered up for minimum 30 to 60 minutes before starting the calibration.

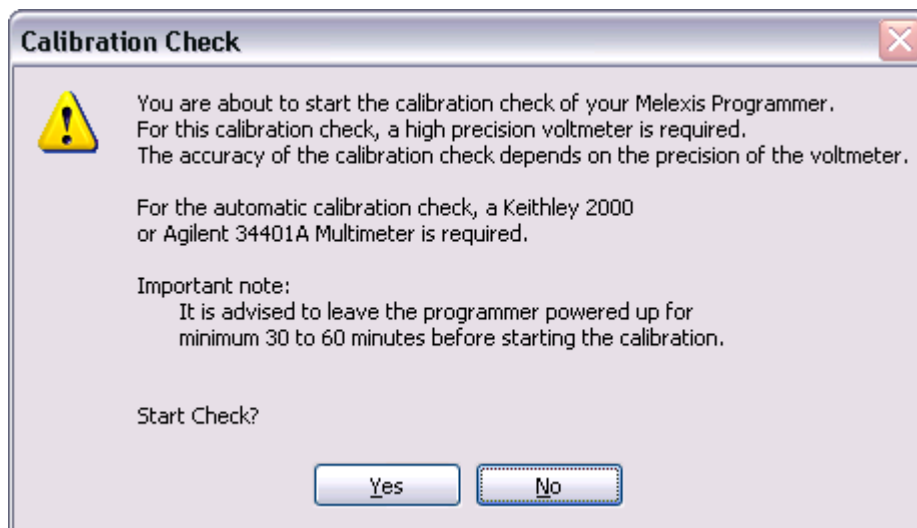

Figure 7: Start Check?

- Press **yes** to continue.

If you **don't use** a Keithley 2000 or Agilent 34401A multi meter, you have to use a high accuracy voltmeter. The accuracy of the calibration depends on the precision of the voltmeter and the number of digits entered. With a manual voltmeter, the program will start with calibrating the internal voltmeter which will be used to check the PTC04 programmer.

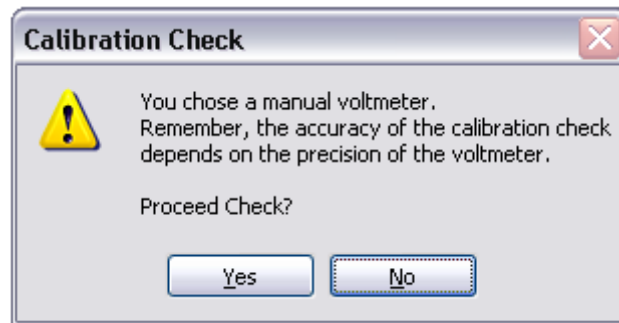

Figure 8: Proceed Check?

- Press **yes** to continue.

At this stage the software will check if the calibration board and, if selected, the Keithley 2000 or Agilent 34401A Multimeter are connected. If the calibration board is not detected, a message is shown.

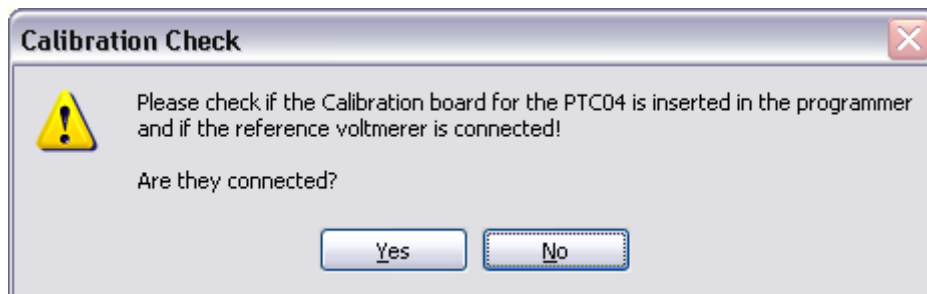

Figure 9: Check setup

- If the setup is not complete, press No, switch of the programmer, check your setup and restart the program.

Manual voltmeter

If the *Keithley 2000* or *Agilent 34401A multimeter* feature is **not** selected the program will ask you to put in a few values from your voltmeter manually. These are used to calibrate the first sensing line of the PTC-04. This sensing line will be used as reference meter for the calibration check.

Note: the accuracy of the calibration depends on the precision of the voltmeter and the number of digits you enter.

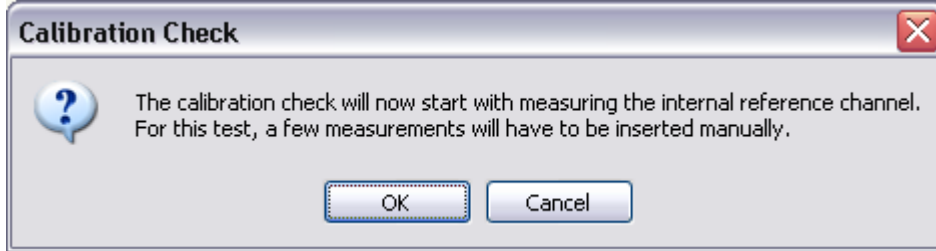

Figure 10: Manual calibration internal reference meter.

- Press **OK** to continue.

For the calibration of the internal reference meter, two series of 32 values are required. Once the internal reference meter is calibrated the software will continue with the calibration check.

Note: the decimal separator of the software is “.” not “,”. If one uses a “,” as decimal separator, the calculated parameters will be incorrect.

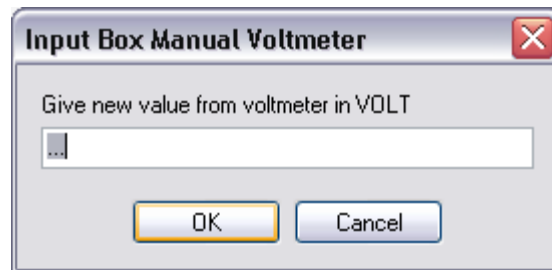

Figure 11: Input Box Manual Voltmeter.

- Insert the value from the voltmeter in volt [V] and press **OK**.

Note: If you entered a wrong value, press **Cancel**. Two error messages are shown.

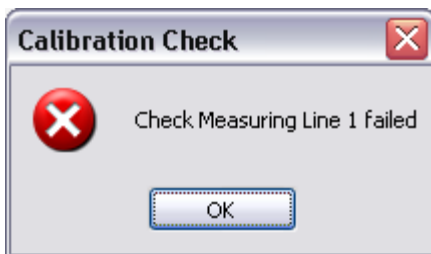

Figure 12: Check Measuring line 1 Failed

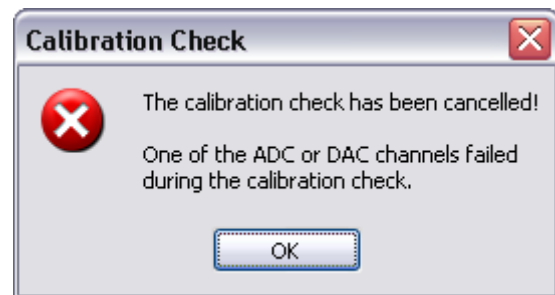

Figure 13: The calibration check has been cancelled.

- Press **OK** on both messages to continue.

Now the calibration check is terminated, you can restart the calibration check.

The calibration check

Now the calibration software will perform a number of measurements on all the ADC and DAC channels of the programmer. This can take several minutes. At the end of the calibration check the program verifies if a correction of the calibration parameters is needed.

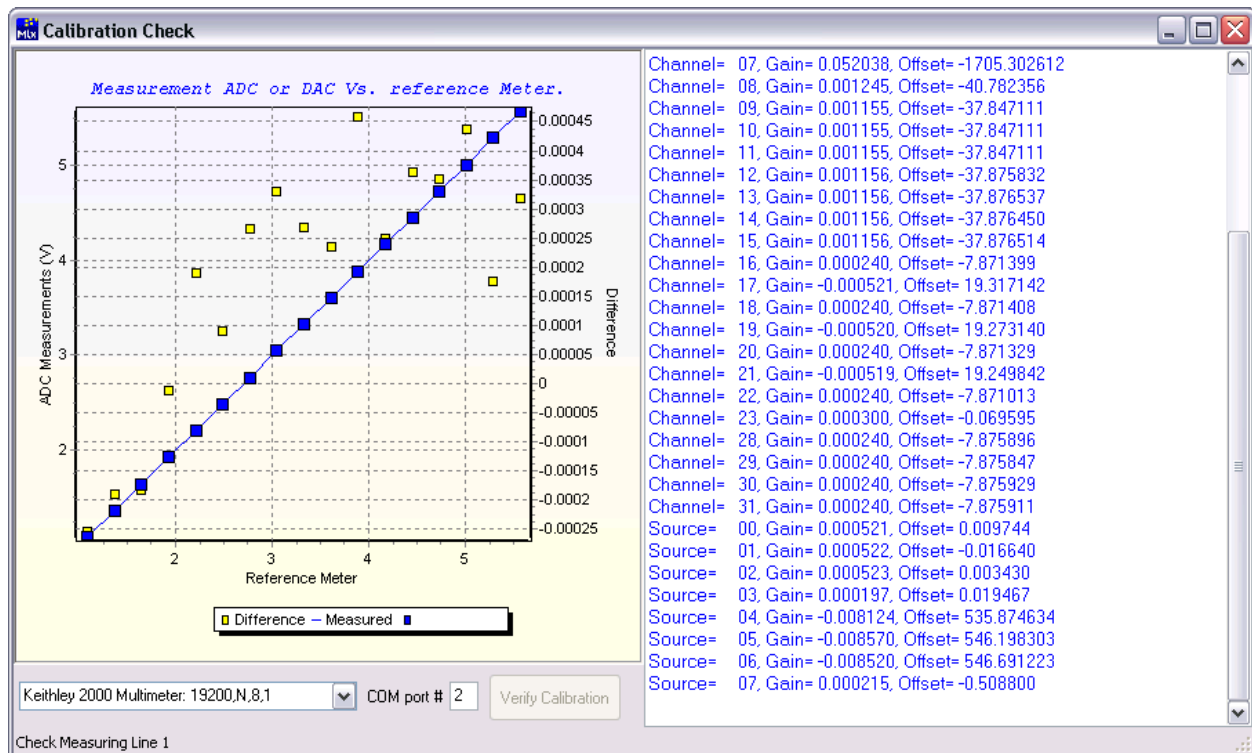

Figure 14: Calibration Check

There are three possible outcomes

1. The program notifies you that the current calibration is out of tolerance and ask you if you want to corrected the calibration parameters or not.

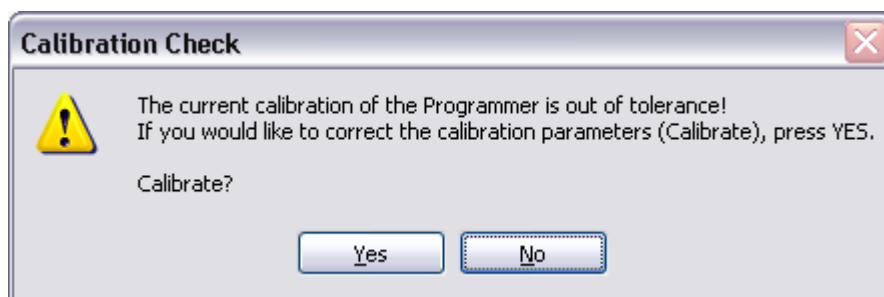

Figure 15: Calibrate?

- If you press **yes**, the new calibration parameters are written into the PTC04.
- If you press **no**, there are no modifications done.

- The program notifies you that the current calibration is within tolerance! No Correction of the calibration parameters (Calibration) is needed.

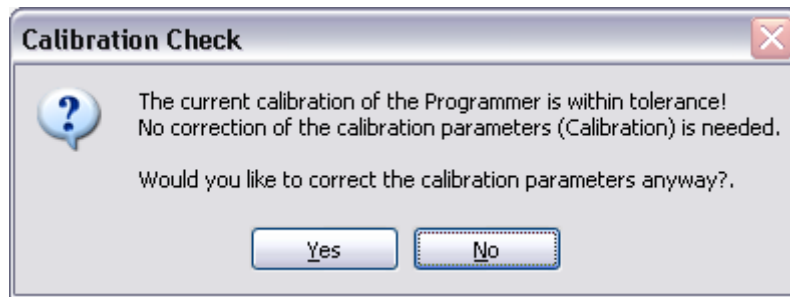

Figure 16: Calibrate Anyway?

If no calibration is needed you can still choose to calibrate or not.

- If you press yes, the new calibration parameters are written into the PTC04.
- If you press no, there are no modifications done.

- At the end of the calibration, the software verifies if the programmer was at temperature when the calibration started. If the programmer was not at temperature, the following message is given.

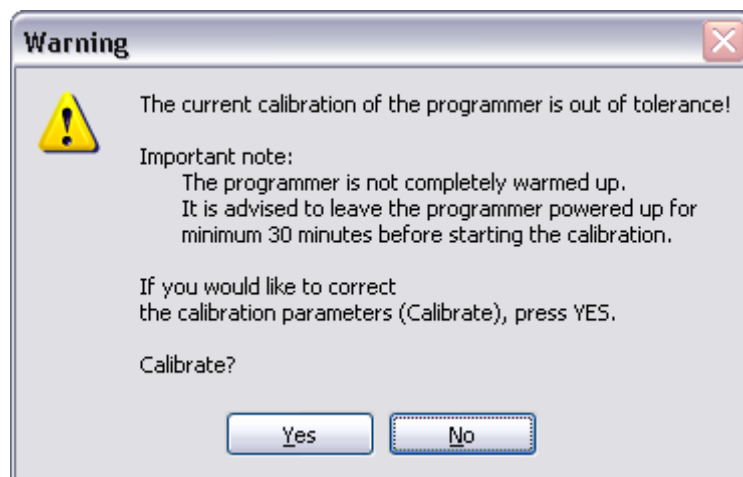

Figure 17: Programmer is not at temperature.

It is advised not to calibrate (store the new calibration parameters in the programmer) when the programmer is not at operating temperature. This is important for the accuracy of the PTC04 programmer.

- If you press **yes**, the new calibration parameters are written into the PTC04.
- If you press **no**, there are no modifications done.

When you choose to calibrate (press **yes**), the new calibration parameters are written into the PTC04. Afterwards the software verifies if the writing of the calibration data in the PTC04 was done correctly.

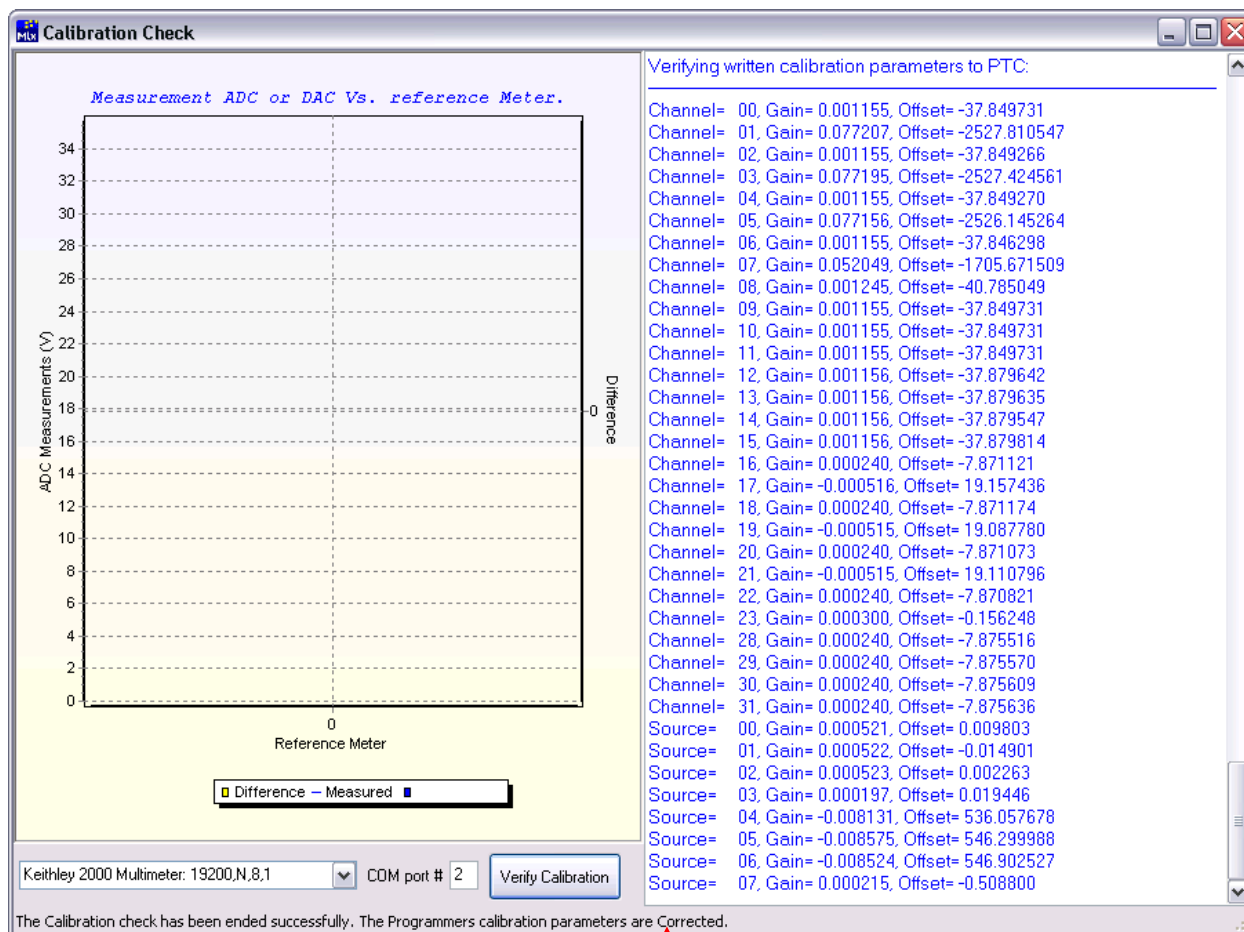

Figure 18: The Calibration check has been ended successfully.

Now the calibration check is completed.

The END status of the calibration check is shown in the status bar of the calibration window.

What if the Calibration check failed

When the calibration fails, it is usually caused by a bad connection, measurement or incorrect input of measured data. If this occurs, check the setup and redo the calibration check.

Very important:

- If the calibration check is done with a manual voltmeter, you have to take extra care that the measurements are done correctly. These measurements are used to calibrate the first sensing line of the PTC-04. This sensing line will be used as reference meter for the calibration check.
- The accuracy of the calibration also depends on the precision of the voltmeter and the number of digits you enter for each measurement.
- The connection of the calibration board and the voltmeter are very important. A bad connection or any additional load will corrupt the calibration parameters.
- The decimal separator of the software is “.” Not “,”. If one uses a “,” as decimal separator, the calibration of the first sensing line will not be done correctly.

Check Calibration Setup

Before the measurements for the calibration check are started, the software will perform a hardware check on the on the calibration setup. This test will verify: if the PTC04 is well connected and in good health, if the PTC04-DB-Calibration is plugged in on the main board, the resistors on the PTC04-DB-Calibration, if the PTC04-DB-Calibration is connected to the reference voltmeter and if the reference voltmeter is connected to the PC (this is not the case for the manual calibration). If the check fails the calibration check will be discontinued. The following message is displayed if a failure is detected on the calibration setup.

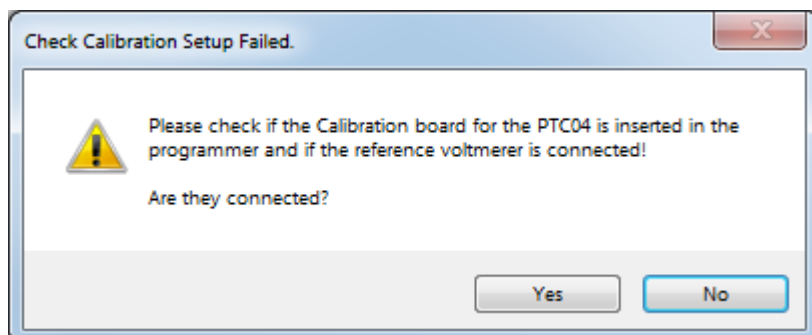

Figure 19: Check calibration setup failed.

Measurement failed

The following error message is shown during the calibration procedure;

- If there is a bad connection in the setup. For example: between the PTC04 main board and the calibration board.
- When using a Keithley 2000 multimeter for the calibration, the failure can also be caused by a wrong measurement of the Keithley. For example: communication error.
- When you are using the manual calibration procedure. The software will perform a check on the data you enter. If there is a large deviation from the expected data. The check will fail and the calibration check is ended.

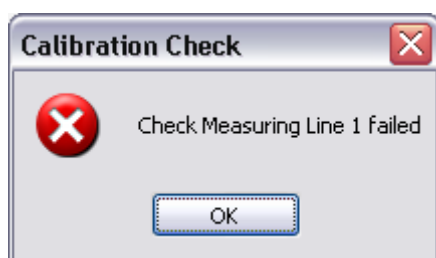

Figure 20: Check Measuring line 1 Failed

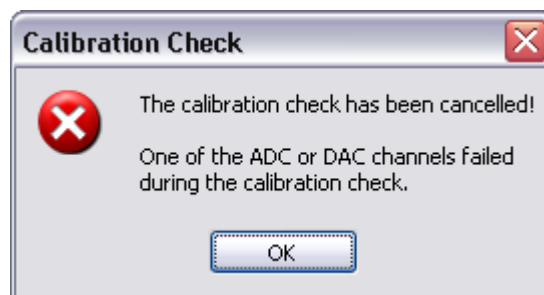

Figure 21: The calibration check has been cancelled.

To determine this:

- Press OK on both messages to cancel the calibration check.
- Remove the calibration board, place it back and check the connections with the voltmeter. The connection of the calibration board and the voltmeter are very important. A bad connection or any additional load will corrupt the calibration parameters.
- After checking the setup, restart the calibration check. If the same channel fails again it is possible that there is hardware damaged on the PTC04. Please contact your local sales representative in this case.

Large deviation

When all the measurements are completed, the software calculates the new calibration parameter. After the calculation of the calibration parameters, the software verifies if there is a large deviation with the standard (expected) calibration parameters. If the deviation is too large the following warning message is shown.

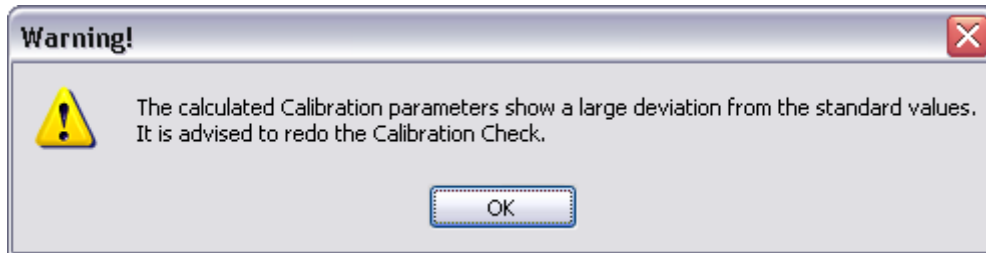

Figure 22: Large deviation of the calibration parameters.

In the main window you get a list of the channels that have a large deviation from the default values.

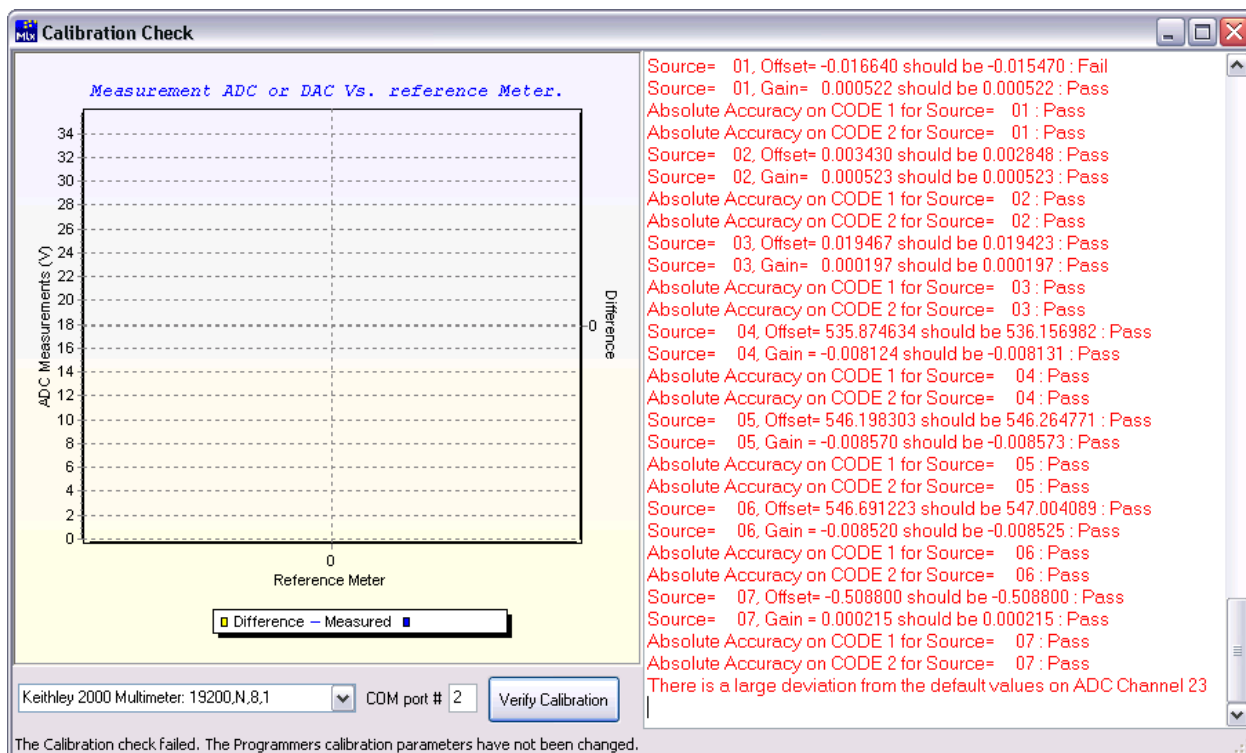

Figure 23: List of channels that have a large deviation.

The large deviation could be a result of incorrect reference measurements.

If it occurs:

- Remove the calibration board, place it back and check the connections with the voltmeter. The connection of the calibration board and the voltmeter are very important. A bad connection or any additional load will corrupt the calibration parameters.
- After checking the setup, restart the calibration check. If the same channel(s) fail(s) again it is possible that there is hardware damaged on the PTC04.

Loggings

Each time a calibration check is performed and the new correction parameters are saved in the PTC-04 programmer, the old and the new parameters are logged in a file called "Calibration_log_PTC04_SN_XXXXXXX.txt", where XXXXXXXX stands for the SN of the PTC04. This file is for information purpose only and **is not used by the PTC-04 programmer**.

The log file is stored under "C:\Users\...\AppData\Roaming\Melexis\PTC04UI" or "C:\Documents and Settings\...\application data\Melexis\PTC04UI".

Calibration details

How does the calibration work?

ADC

In the graph below, you have two curves: the measurements of the ADC (left Y-axis) and the reference measurements of the external voltmeter (the right Y-axis). The internal voltage source is used as supply (Set DAC X-axis). The purpose of the calibration check is to compare the ADC with the external high precision voltmeter.

For the check, a number of voltage values are measured to calculate the difference between the ADC of the PTC04 and the External Voltmeter which results in to correction parameters for offset and gain.

Calibration check ADC

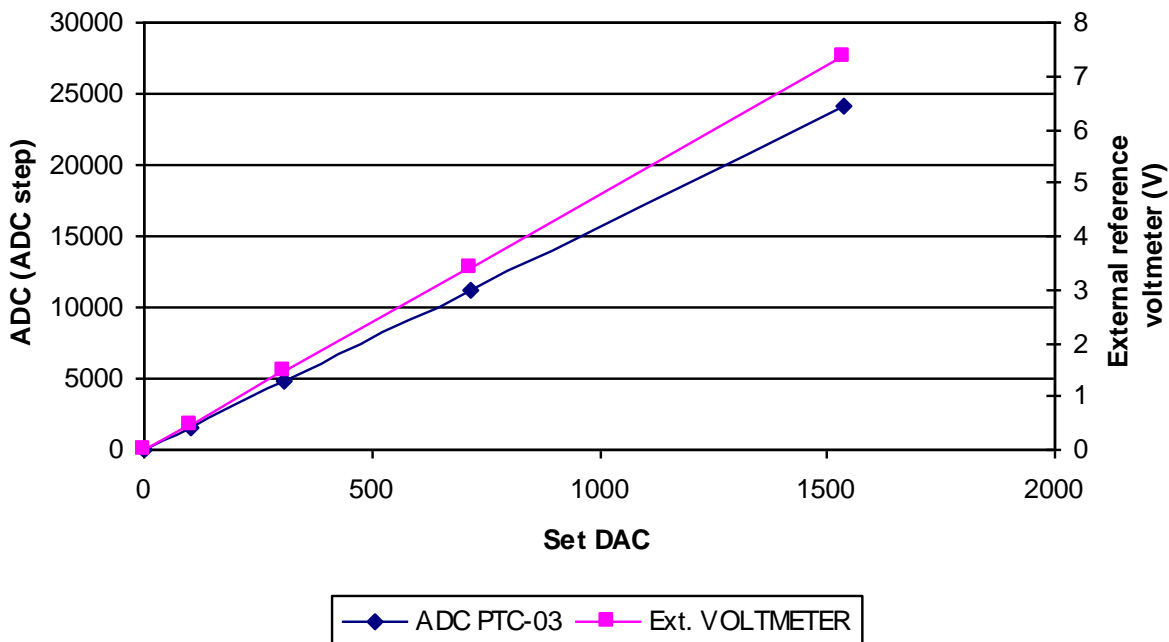

Graph 1

DAC

In the 2nd graph, you have again two curves: the Set DAC (left Y-axis) and the reference measurements of the external voltmeter (the right Y-axis). The purpose of the calibration check is to compare the DAC with the external high precision voltmeter.

Also for this check, a number of values are measured to calculate the difference between the DAC of the PTC04 and the External Voltmeter which results in to correction parameters for offset and gain.

Calibration check DAC

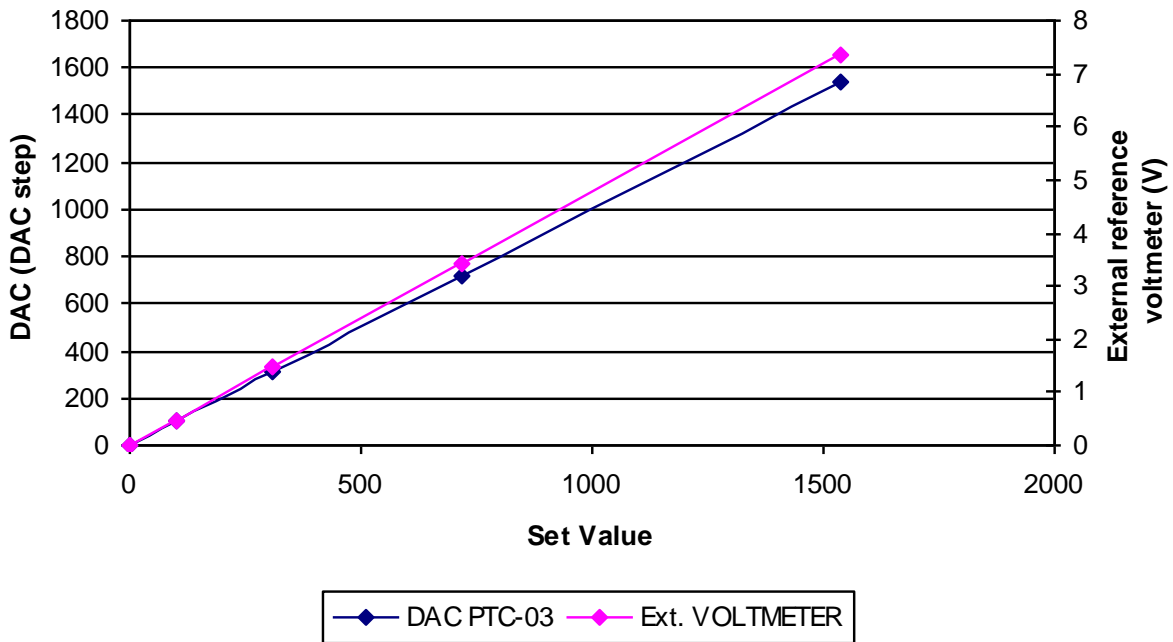

Graph 2

At the end of the calibration check these values, of the ADC channels and the DAC, are compared with the values stored in the PTC. If the parameters for offset and gain, that are currently stored in the PTC04, are out of specifications in comparison with the new correction parameters, the software gives a warning and asks if the new correction parameter may be saved.

What do we calibrate?

Sensing lines:

There are four sensing lines with independent ground connection.

The source and reference that are used to calibrate the sensing lines are PPS 1 and the external voltmeter.

Sensing line 1	channel 12 and Channel 28 (High sensitivity) of the ADC ;
Sensing line 2	channel 13 and Channel 29 (High sensitivity) of the ADC ;
Sensing line 3	channel 14 and Channel 30 (High sensitivity) of the ADC ;
Sensing line 4	channel 15 and Channel 31 (High sensitivity) of the ADC .

PPS1:

For each PPS, the software checks the ADC first then the DAC and then the additional channels that are connected to that source.

Voltmeter on the PPS1	channel 0 and Channel 16 (High sensitivity) of the ADC ;
PPS1	channel 0 of the DAC ;
Current meter on the PPS1	channel 1 of the ADC ;
PPS 5: IDD limiter PPS1	channel 4 of the DAC .

PPS2:

Voltmeter on the PPS2	channel 2 and Channel 18 (High sensitivity) of the ADC ;
PPS2	channel 1 of the DAC ;
Current meter on the PPS2	channel 3 of the ADC ;
PPS 6: IDD limiter PPS2	channel 5 of the DAC .

PPS3:

Voltmeter on the PPS3	channel 4 and Channel 20 (High sensitivity) of the ADC ;
PPS3	channel 2 of the DAC ;
Current meter on the PPS3	channel 5 of the ADC ;
PPS7: IDD limiter PPS3	channel 6 of the DAC .

PPS4:

Voltmeter on the PPS4	channel 6 and Channel 22 (High sensitivity) of the ADC ;
PPS4	channel 3 of the DAC ;
Current meter on the PPS4	channel 7 of the ADC ;
PPS8: IDD limiter PPS4	channel 7 of the DAC .

Contact

For the latest version of this document, go to our website at www.melexis.com.

For additional information, please contact our Direct Sales team and get help for your specific needs:

Europe, Africa	Email : sales_europe@melexis.com
Americas	Email : sales_usa@melexis.com
Asia	Email : sales_asia@melexis.com

Disclaimer

The information furnished by Melexis herein ("Information") is believed to be correct and accurate. Melexis disclaims (i) any and all liability in connection with or arising out of the furnishing, performance or use of the technical data or use of the product(s) as described herein ("Product") (ii) any and all liability, including without limitation, special, consequential or incidental damages, and (iii) any and all warranties, express, statutory, implied, or by description, including warranties of fitness for particular purpose, non-infringement, and merchantability. No obligation or liability shall arise or flow out of Melexis' rendering of technical or other services.

The Information is provided 'as is' and Melexis reserves the right to change the Information at any time and without notice. Therefore, before placing orders and/or prior to designing the Product into a system, users or any third party should obtain the latest version of the relevant information to verify that the information being relied upon is current. Users or any third party must further determine the suitability of the Product for its application, including the level of reliability required and determine whether it is fit for a particular purpose. The Information is proprietary and/or confidential information of Melexis and the use thereof or anything described by the Information does not grant, explicitly or implicitly, to any party any patent rights, licenses, or any other intellectual property rights. This document, as well as the Product(s), may be subject to export control regulations. Please be aware that export might require prior authorization from competent authorities. The Product(s) are intended for use in normal commercial applications. Unless otherwise agreed upon in writing, the Product(s) are not designed, authorized or warranted to be suitable in applications requiring extended temperature range and/or unusual environmental requirements. High-reliability applications, such as medical life-support or life-sustaining equipment are specifically not recommended by Melexis. The Product(s) may not be used for the following applications subject to export control regulations: the development, production, processing, operation, maintenance, storage, recognition or proliferation of

- 1. chemical, biological or nuclear weapons, or for the development, production, maintenance or storage of missiles for such weapons;*
- 2. civil firearms, including spare parts or ammunition for such arms;*
- 3. defense-related products, or other material for military use or for law enforcement;*
- 4. any applications that, alone or in combination with other goods, substances or organisms could cause serious harm to persons or goods and that can be used as a means of violence in an armed conflict or any similar violent situation.*

The Products sold by Melexis are subject to the terms and conditions as specified in the Terms of Sale, which can be found at <https://www.melexis.com/en/legal/terms-and-conditions>.

This document supersedes and replaces all prior information regarding the Product(s) and/or previous versions of this document.

Melexis NV © - No part of this document may be reproduced without the prior written consent of Melexis. (2021)

IATF 16949 and ISO14001 Certified