

PTC04-DB-HALL05

Daughter Board for Melexis PTC devices

Features and Benefits

PTC04 interface board for testing devices:

- MLX91208
- MLX91209

Applications

Experimental tool for Lab and Prototyping
Production Equipment for Serial Programming

Ordering Information

Part No.	Description
PTC04-DB-Hall05	Daughter Board (PCB + rear panel PTC04)

Accessories

Part No.	Description
	DLL's for all supported products
	User Inter Faces for supported products
	Firmware for supported products

1. Functional Diagram

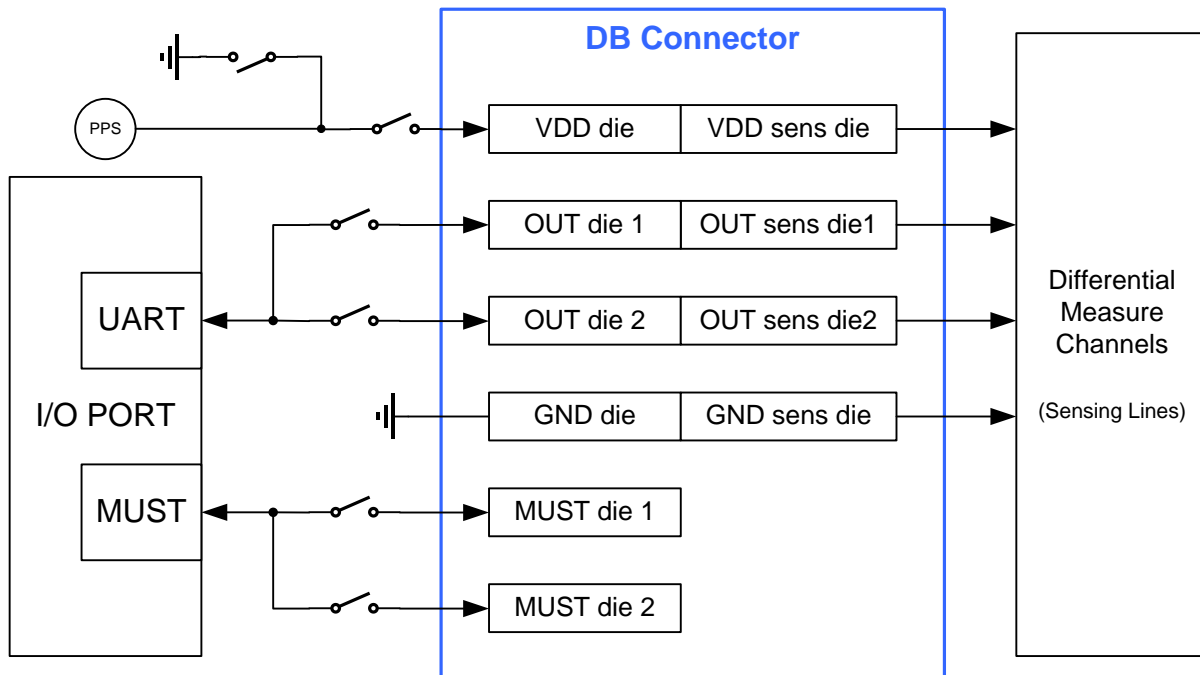

Figure 1: Functional Diagram

Contents

Features and Benefits.....	1
Applications.....	1
Ordering Information	1
Accessories.....	1
1. Functional Diagram	1
2. Board description	3
2.1. Board Layout	3
2.2. Board Schematics.....	4
2.3. Daughter board Connectors.....	6
2.3.1. Digital DB Connector (40 Pins).....	7
2.3.2. Analog DB Connector (48 Pins).....	7
2.4. Application Connector	8
2.5. Jumper Selection.....	9
3. Contact.....	10
4. Disclaimer.....	11

2. Board description

2.1. Board Layout

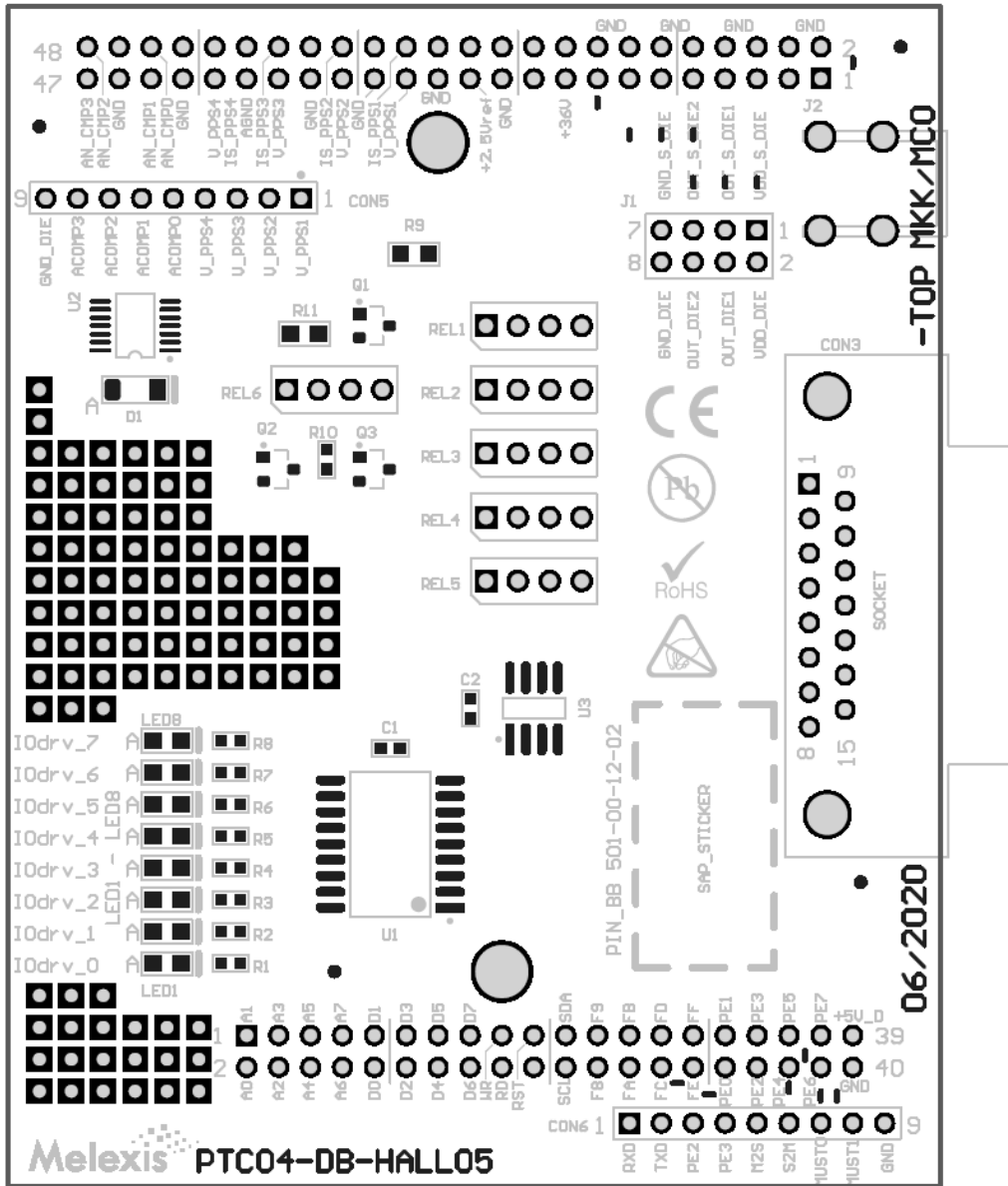

Figure 2: Board Layout Top Layer.

- J1: Force & Sens: Jumpers to connect the measurement sensing lines immediately to the force lines. These jumpers are needed when no force and sens is used.
- U3: DB-ID: This ID keeps a few initial variables in mind. It allows for example to detect what DB is connected to the programmer and if the DB is not expired.
- CON1 – CON2 : Analogue and Digital connector: See below for a detailed description.
- CON3: Application Connector: Dsub15 way connector to the application. See below for details.
- LED1-8 Indicators: 8 LED Indicators for the DB_IODrv lines.
- J2: GND connection to back panel.

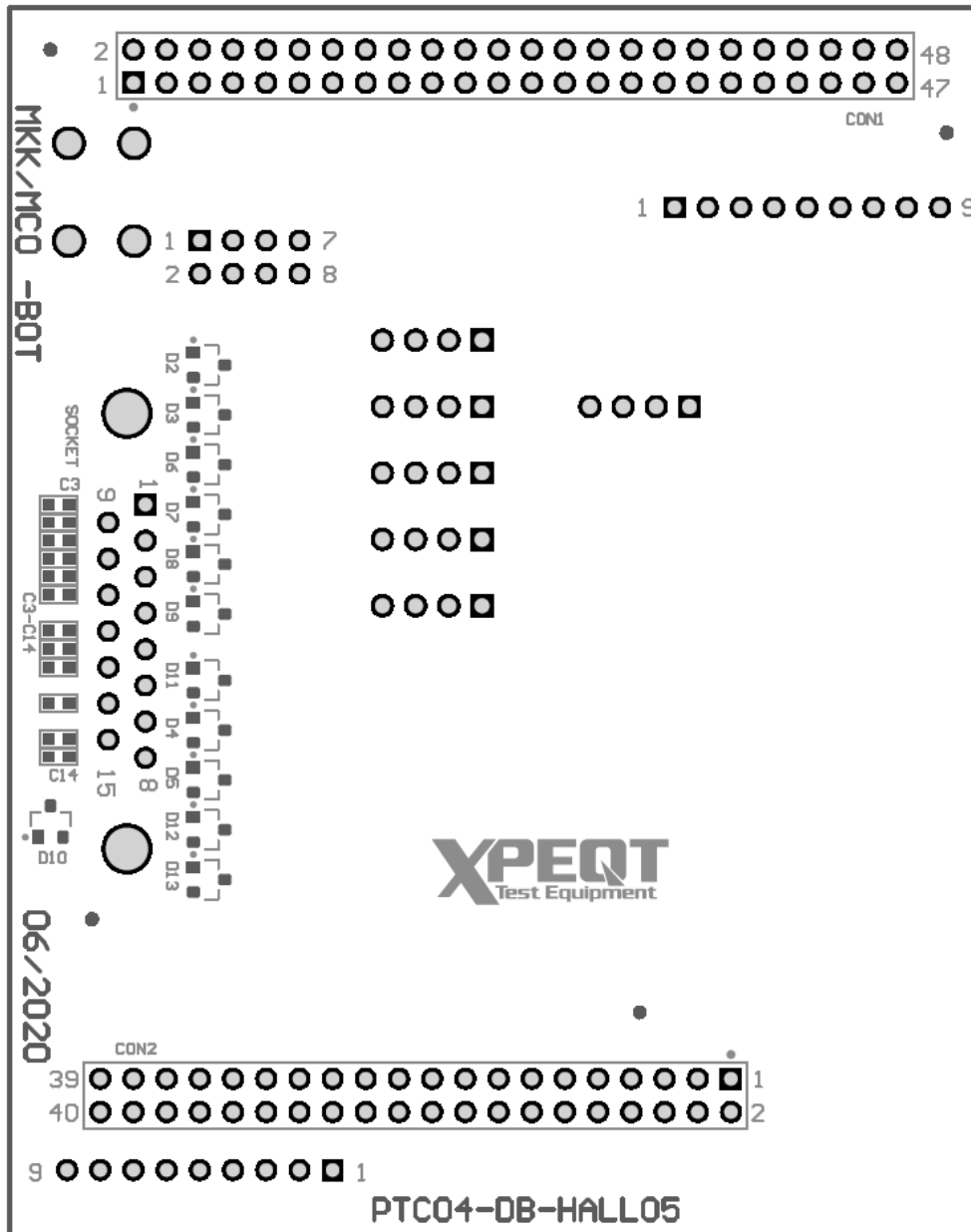
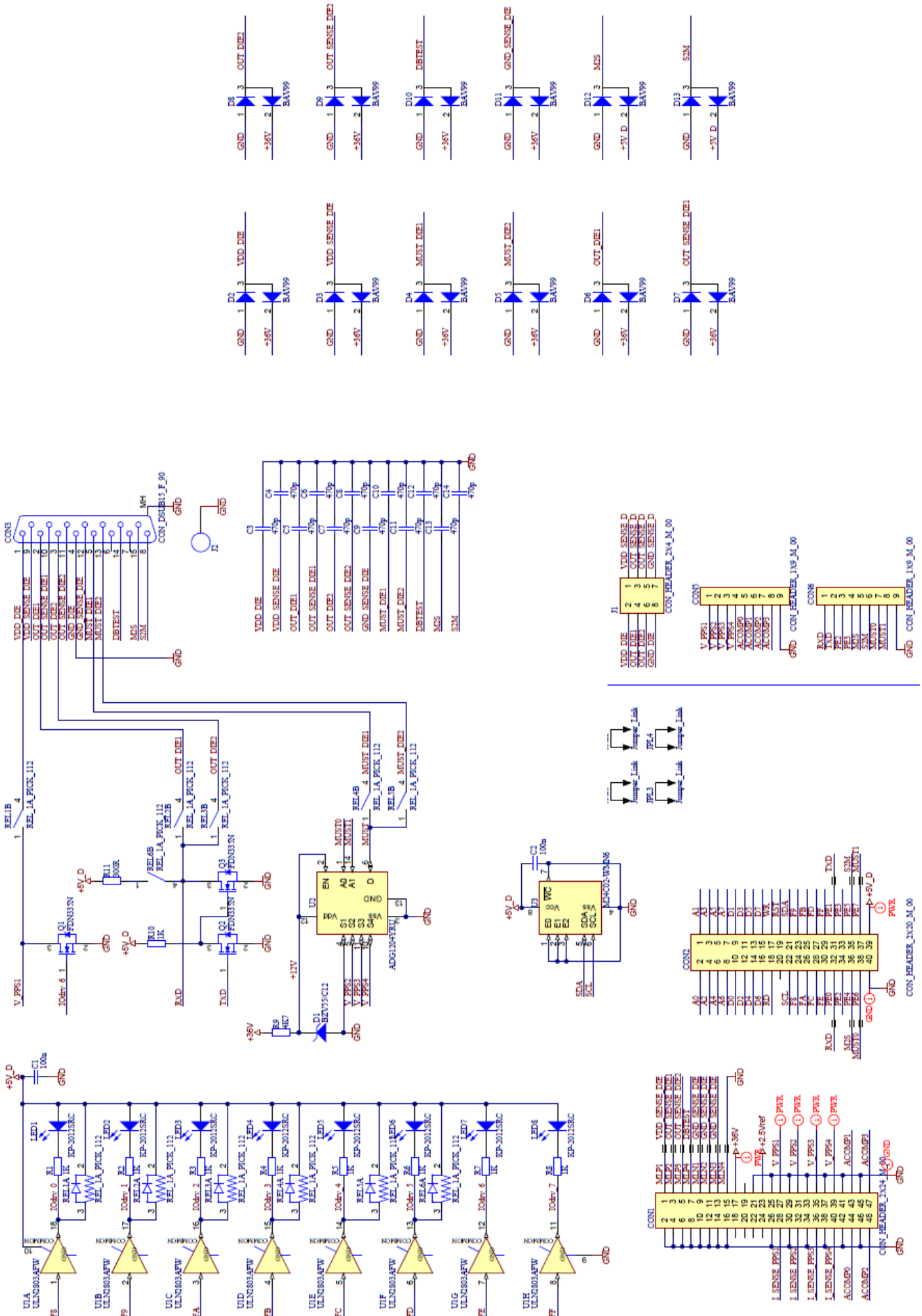

Figure 3: Board Layout Bottom Layer.

2.2. Board Schematics

Below you can find the complete schematics of the DB:

Figure 4: Board Schematics.



2.3. Daughter board Connectors

The PTC04 main board has two connectors to the interface with the application. The PTC allows adding a full PCB in between (Daughter Board). This daughter board can be mounted on the two connectors. In some exceptional cases, a daughter board contains only a few wires from the Analogue connector to the application connector. The pins on of the connectors are described below.

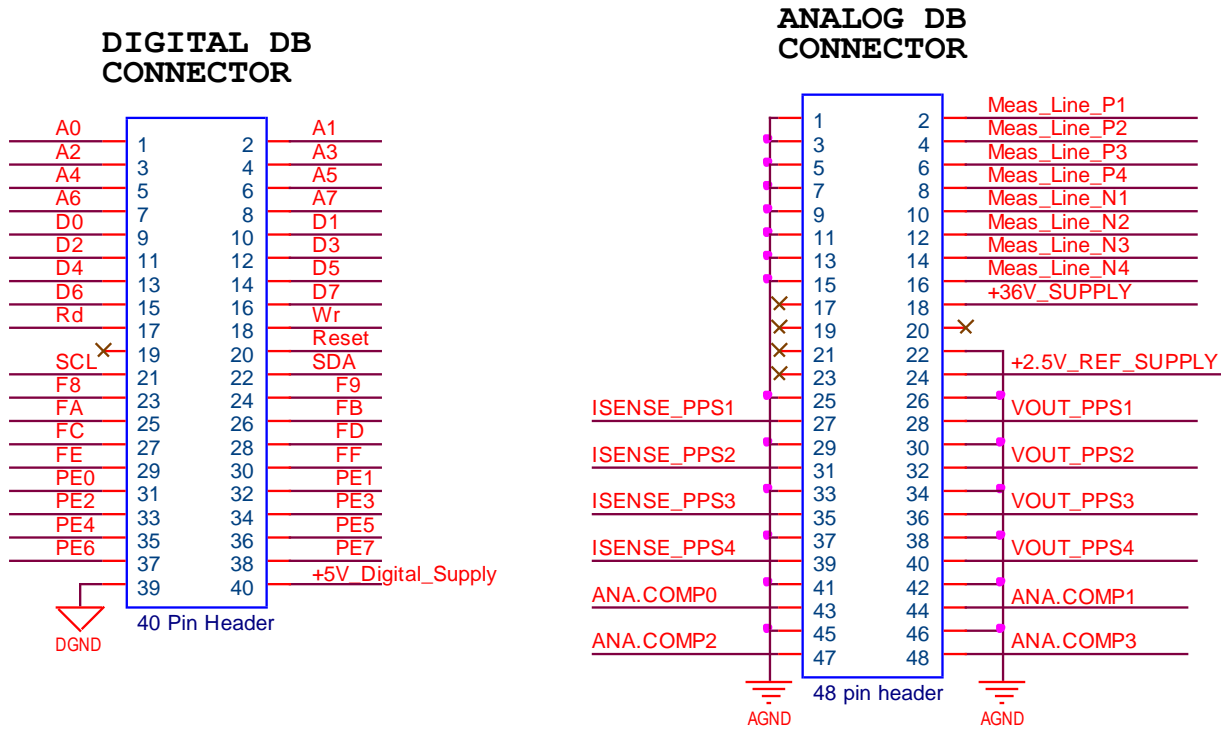

Figure 5: Daughter Board Connectors

2.3.1. Digital DB Connector (40 Pins)

Mainly, the digital connector is meant to expand the programmer to extra needs. Address lines A0-A7 together with the Map Select Lines F8-FF allows to direct access an area of 2 K. Examples would be adding a simple addressed I/O register by using the selection lines. If more complexity is needed, a full FPGA can be mounted on the DB board

Pins	Names	Description
1 – 8	A0 – A7	Address lines
9 – 16	D0 – D7	Data Lines active during Rd or Wr signals
17	Rd	Read: A negative pulse will indicate a sampling of the data on the Data Bus
18	Wr	Write: A Negative pulse will indicate when data is available on the Data Bus
20	Reset	This signal goes low by powering the PTC or by pressing the reset button. This line can be pulled low by application. Check firmware documentation for resetting by software.
21-22	SCL / SDA	I2c Bus
23-30	F8,F9,...,FF	CS lines when the address areas are accessed
31-38	Port E	Note: These pins are limited to 5 Volt input\output!!!! The full Port E of the Atmega core is mounted to these pins. This allows us to use advanced features like PWM, UARTS, Time Measurements, etc.... By using firmware that supports these, functions, application specific requirements can be fulfilled.
39	DGND	Digital Ground
40	+5V Digital	5 Volt Digital Supply. Maximum current to get out of this supply: 250mA

Note: All the pins are limited to 5 Volt input\output!!!! However, there are Protections, please take precautions in order to avoid damage of the main board.

2.3.2. Analog DB Connector (48 Pins)

Mainly, the analog connector provides all the analog signals and measure possibilities.

Pins	Names	Description
28,32,36	PPS 1-3	Output of the Programmable Supplies
40	PPS 4	Output of the Fast DAC Programmable Power Supply
27,31,35,39	Isense_PP1-4	Outputs (Driver outputs before Rsens) for current evaluations. These outputs could be used to connect to the analog comparators in order to create fast digital signals based on current.
2,4,6,8	ExtMeas1-4Pos	There are 4 differential inputs for making measurements
10,12,14,16	ExtMeas1_4Neg	The negative inputs of ExtMeas1-4Pos
17,19,21,23	Shtd_PPS1-4	Outputs that shows the status of the Drivers. Signals are meant to connect LED's to put the front panel
43,44,47,48	AnaComp0-3	Input (limited to 5V) See *Note. Fast Level comparators in order to remove time consuming measurement
18	+35V_Supply	Supply to extend the daughter board with some extra drivers
24	+2.5V Ref	Output of internal reference
All other	AGND	Analog Ground

Note: All the pins are limited to 35 Volt input\output!!!! However, there are Protections, please take precautions in order to avoid damage of the main board.

** Note: Some pins are protected and limited to 5 Volt!!!! However, there are Protections, please take precautions in order to avoid damage of the main board.*

2.4. Application Connector

The figure and table below shows the connections as provided by the daughterboard PTC04-DB-HALL05.

The view of the connector is **front view** for the **female** connector of the PTC04-DB- HALL05 which corresponds to the **solder side** of the **male** connector.

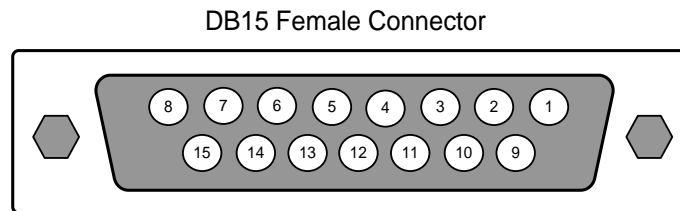

Pins	Names	Description	Package Pin #	
			91208 SOIC	91209 VA
1	VDD_DIE	Device Supply both dies	5	1
2	OUT_DIE1	Device Output Die 1	6	2
3	OUT_DIE2	Device Output Die 2	n/a	n/a
4	GND_DIE	Analogue Ground both dies	3	4
5	TEST_MUST_DIE1	Digital test pin – MUST	4	3
6	NC	Not Connected	NC	NC
7	NC	Not Connected	NC	NC
8	S2M	Master-Slave approach	n/a	n/a
9	VDD_SENS_DIE	Sensing Device Supply	5	1
10	OUT_SENS_DIE1	Sensing Device Output Die 1	6	2
11	OUT_SENS_DIE2	Sensing Device Output Die 2	n/a	n/a
12	GND_SENS_DIE	Sensing Analogue Ground Device	3	4
13	TEST_MUST_DIE2	Digital test pin – MUST	n/a	n/a
14	NC	Not Connected	NC	NC
15	M2S	Master-Slave approach	n/a	n/a

2.5. Jumper Selection

The D-SUP DA-15 connector of the daughter board is equipped with a sensing line for each analog device pin.

The top row is the force line of the device pins. The bottom row is the sensing line of the device pins.

Between each force and sense line there is a jumper to short the sense line at the D-SUP DA-15 connector on the daughter board.

The jumper is placed when the external sensing is not required. For example: an application with a digital or PWM output.

Single wire connection

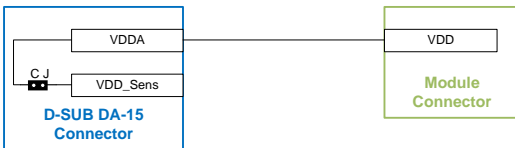

When the jumper is closed, only one wire is required **per pin** between the PTC-04 and the module or sensor.

In the table above these pins are marked as “Minimum required single/dual die connection”.

In this configuration the measurement of VDD, OUT1 or OUT2 is done at the D-SUB DA-15 connector of the PTC04-DB-HALL05.

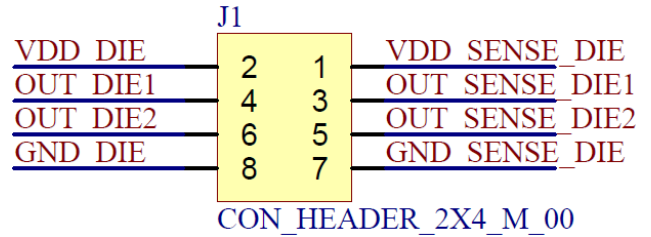

Figure 6: Jumper between force and sense line.

J1 is used to short the force and sense line of the analog device pins.

In other words, they are used to select single wire or double wire connection to the pin of the module / sensor

Double wire connection



When the jumper is open, two wires are required **per pin** between the PTC-04 and the module or sensor.

With two wires connected at the module side, the measurement of VDD, OUT1 or OUT2 is done on the module or sensor connector.

The external sensing line per pin is only required for applications with an analog sensor output and where a higher measuring accuracy is required.

3. Contact

For the latest version of this document, go to our website at www.melexis.com.

For additional information, please contact our Direct Sales team and get help for your specific needs:

Europe, Africa	Telephone: +32 13 67 04 95
	Email : sales_europe@melexis.com
Americas	Telephone: +1 603 223 2362
	Email : sales_usa@melexis.com
Asia	Email : sales_asia@melexis.com

4. Disclaimer

The content of this document is believed to be correct and accurate. However, the content of this document is furnished "as is" for informational use only and no representation, nor warranty is provided by Melexis about its accuracy, nor about the results of its implementation. Melexis assumes no responsibility or liability for any errors or inaccuracies that may appear in this document. Customer will follow the practices contained in this document under its sole responsibility. This documentation is in fact provided without warranty, term, or condition of any kind, either implied or expressed, including but not limited to warranties of merchantability, satisfactory quality, non-infringement, and fitness for purpose. Melexis, its employees and agents and its affiliates' and their employees and agents will not be responsible for any loss, however arising, from the use of, or reliance on this document. Notwithstanding the foregoing, contractual obligations expressly undertaken in writing by Melexis prevail over this disclaimer.

This document is subject to change without notice, and should not be construed as a commitment by Melexis. Therefore, before placing orders or prior to designing the product into a system, users or any third party should obtain the latest version of the relevant information. Users or any third party must determine the suitability of the product described in this document for its application, including the level of reliability required and determine whether it is fit for a particular purpose.

This document as well as the product here described may be subject to export control regulations. Be aware that export might require a prior authorization from competent authorities. The product is not designed, authorized or warranted to be suitable in applications requiring extended temperature range and/or unusual environmental requirements. High reliability applications, such as medical life-support or life-sustaining equipment or avionics application are specifically excluded by Melexis. The product may not be used for the following applications subject to export control regulations: the development, production, processing, operation, maintenance, storage, recognition or proliferation of:

- 1. chemical, biological or nuclear weapons, or for the development, production, maintenance or storage of missiles for such weapons;*
- 2. civil firearms, including spare parts or ammunition for such arms;*
- 3. defense related products, or other material for military use or for law enforcement;*
- 4. any applications that, alone or in combination with other goods, substances or organisms could cause serious harm to persons or goods and that can be used as a means of violence in an armed conflict or any similar violent situation.*

No license nor any other right or interest is granted to any of Melexis' or third party's intellectual property rights.

If this document is marked "restricted" or with similar words, or if in any case the content of this document is to be reasonably understood as being confidential, the recipient of this document shall not communicate, nor disclose to any third party, any part of the document without Melexis' express written consent. The recipient shall take all necessary measures to apply and preserve the confidential character of the document. In particular, the recipient shall (i) hold document in confidence with at least the same degree of care by which it maintains the confidentiality of its own proprietary and confidential information, but no less than reasonable care; (ii) restrict the disclosure of the document solely to its employees for the purpose for which this document was received, on a strictly need to know basis and providing that such persons to whom the document is disclosed are bound by confidentiality terms substantially similar to those in this disclaimer; (iii) use the document only in connection with the purpose for which this document was received, and reproduce document only to the extent necessary for such purposes; (iv) not use the document for commercial purposes or to the detriment of Melexis or its customers. The confidentiality obligations set forth in this disclaimer will have indefinite duration and in any case they will be effective for no less than 10 years from the receipt of this document.

This disclaimer will be governed by and construed in accordance with Belgian law and any disputes relating to this disclaimer will be subject to the exclusive jurisdiction of the courts of Brussels, Belgium.

The invalidity or ineffectiveness of any of the provisions of this disclaimer does not affect the validity or effectiveness of the other provisions. The previous versions of this document are repealed.

Melexis © - No part of this document may be reproduced without the prior written consent of Melexis. (2020)

IATF 16949 and ISO 14001 Certified