

# Melexis

INSPIRED ENGINEERING

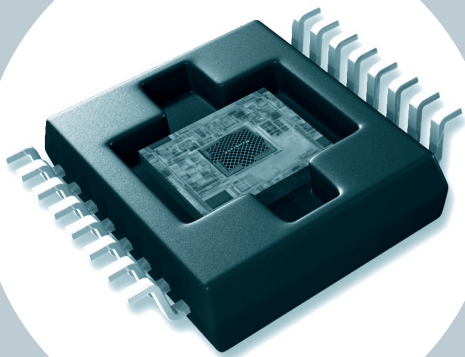

LET'S TAKE YOU  
ON A TRIP THROUGH  
**THE SECRET LIFE OF  
A SILICON CHIP ...**

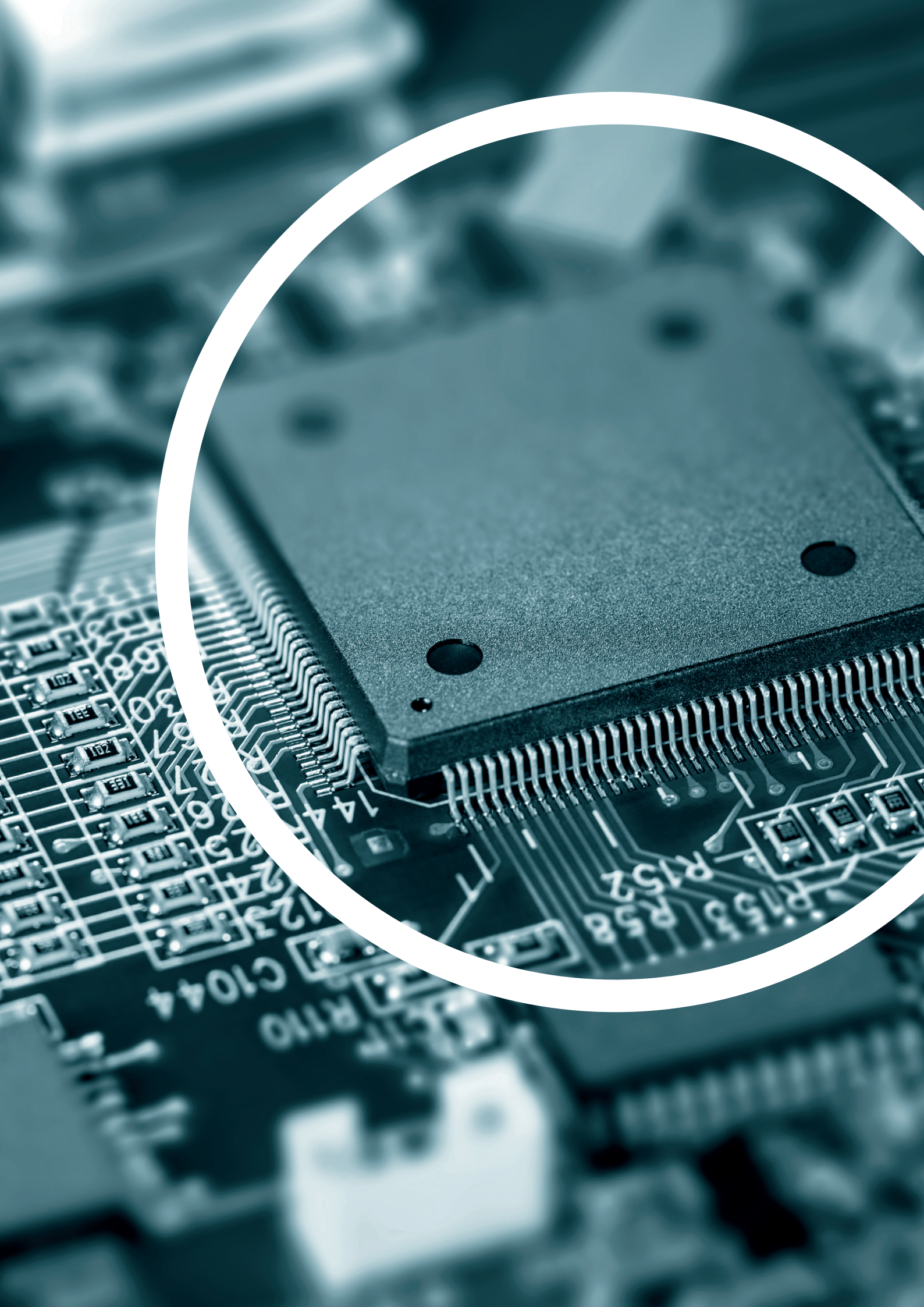





# TABLE OF CONTENTS

|   |          |
|---|----------|
| • Inspired engineering  | 4        |
| • What is an integrated circuit?  | 5        |
| • <b>Let's take you on a trip<br/>through the secret life of a silicon chip ...</b> | <b>8</b> |
| • <b>01</b> Off to a running start  | 10       |
| • <b>02</b> Engineering with a purpose  | 12       |
| • <b>03</b> Welcome to chip city  | 14       |
| • <b>04</b> Picture perfect   | 16       |
| • <b>05</b> The test of time  | 18       |
| • <b>06</b> The total package   | 20       |
| • <b>07</b> The final countdown   | 22       |
| One for the road  | 24       |
| • <b>08</b> A sense of things to come   | 26       |
| The saga continues  |          |

# INSPIRED ENGINEERING

At Melexis, we are all about inspired engineering. Our passion for technology has made us one of the five world leaders in automotive semiconductor sensors, as well as a leading player in integrated circuits for motor driving, car networking and wireless communication.

We play a leading role in developing new products and categories and we keep a close eye on the rapidly evolving industry needs. For example, we are pioneers in 3D magnetic Hall effect sensors, and we constantly improve production capabilities for sensor assemblies and modules.

Melexis has a well-matched team of experienced engineers. Their expertise in product definition, design and testing of integrated analog-digital semiconductor solutions and sensor chips has placed Melexis in a leading position.

Each new  
car produced  
today, wherever in  
the world, contains  
an average of 8  
Melexis chips.





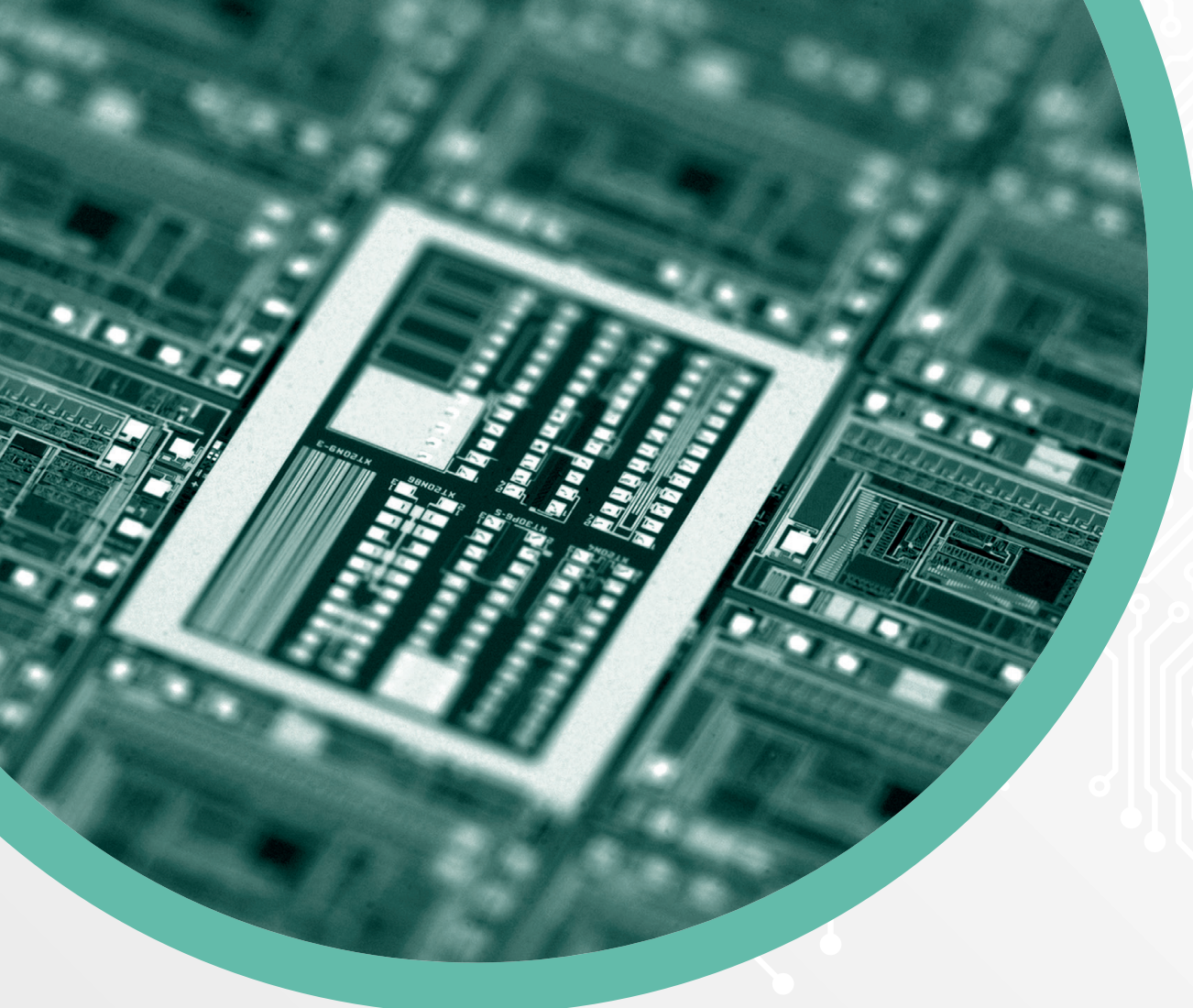

# WHAT IS AN INTEGRATED CIRCUIT?

Melexis is a worldwide expert in making micro-electronic integrated circuits. But what exactly is an integrated circuit (IC)? We all know how electricity is harnessed by switches and lights and motors, to perform tasks to ease our daily efforts. A simple switch allows the light to be turned on or off. The thermostat in our home measures and controls the heating system that keeps us comfortable without any effort. These are simple examples of electricity harnessed in service to society.

More complex examples include smartphones and notebooks, as well as the life saving airbag systems in your car. These complex systems are both the result of innovation in electricity and electronics and the motivation of endless engineering creativity.



Through the '70s and '80s, the complexity of integrating both digital and analog on a single chip prevented effective mixed signal systems on it. The development of CMOS analog circuit techniques and mixed process Bipolar- CMOS fabrication enabled a new category of ICs that allowed truly system level integration.

Beginning with simple switches and wires, the telephone was invented by Alexander Graham Bell. Mr. Marconi and Mr. Tesla, among others, freed our voices from this mechanical world of wires and switches. The vacuum tube was at its simplest a switch to control electricity. Unfortunately it was fragile, created excessive heat while doing its job and was the size of an adult's three fingers held together.

Physicists and engineers worked hard to invent a successor to these vacuum tubes. Their resulting innovation was called the transistor. Early transistors were immediately used to solve problems in the electronics systems of the day. For instance, they were the key enabler to man reaching the moon.

In the early days only a single transistor was built onto a square of silicon. In 1968 at Bell Labs the integrated circuit was first demonstrated. This combination of transistors, resistors and capacitors intensified the pace of electronics developments. To this event all modern electronic devices owe their existence. Rapid evolution of the technology resulted in the operational amplifier, the microprocessor, the ROM and DRAM memory chips and integrated sensors like photodiodes and Hall ICs.



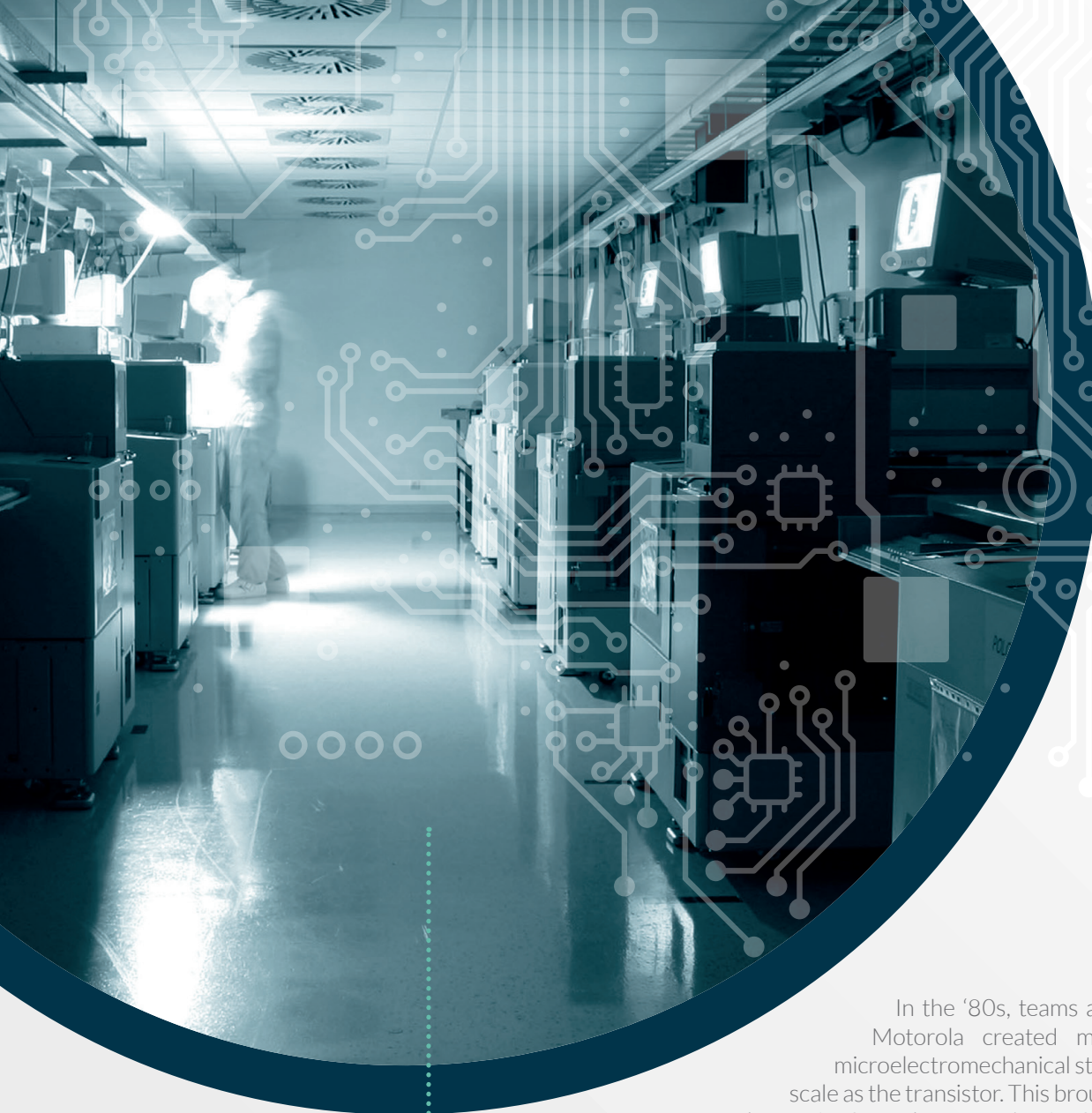

In the '80s, teams at Stanford, IBM and Motorola created methods for making microelectromechanical structures on the same scale as the transistor. This brought the revolution of electronics from electromechanics full circle.

The growth of ICs followed along two major paths: initially analog ICs dominated developments and later digital ICs took the lead. Analog ICs were applied in amplifiers, RF, power and instrumentation challenges. Digital ICs were applied in logic functions like calculators, counters, computers and memory systems. With time the integration levels and component density on ICs improved. This allowed for higher performance analog components and higher density integrated digital circuits. The exponential rate of growth prompted the famous "Moore's Law" attributed to Gordon Moore. This law predicted the doubling of processing power in ICs approximately every two years.

The most recent advancements in IC technology allow implementation of mechanically active components into the silicon. These microelectromechanical (MEMS) structures are ideal for creating sensors or structures that interact with the mechanical world. This brings us to the present day. Now Melexis is able to supply markets with fully integrated systems on a chip that include analog, digital and MEMS components, effectively integrating complete solutions in one microminiature package.



# LET'S TAKE YOU ON A TRIP THROUGH THE SECRET LIFE OF A SILICON CHIP ...

## SMALL WONDERS

Did you know that a grain of sand can ultimately help you drive more smoothly, safely and sustainably? This tiniest of materials is the start of semiconductor chip technology. Every chip consists of tens of thousands of basic elements, such as transistors, resistors and capacitors and takes approximately six months to complete! At Melexis we take care of this whole process, apart from the wafer construction and the packaging of the working chips, which are carried out by a third party.

### 01 OFF TO A RUNNING START



### 02 ENGINEERING WITH A PURPOSE

BY MELEXIS



BY MELEXIS



BY THIRD

### 03 WELCOME TO CHIP CITY

# 04 PICTURE PERFECT

# 05 THE TEST OF TIME

# 06 THE TOTAL PACKAGE

# 07 THE FINAL COUNTDOWN

# 08 A SENSE OF THINGS TO COME



[www.melexis.com](http://www.melexis.com)



# OFF TO A RUNNING START

Before we design a chip, we need to define it. We have to make sure it fully meets our customer's needs, so we collect all information on the chip's functions and operating conditions, such as temperature, current, pressure and more.

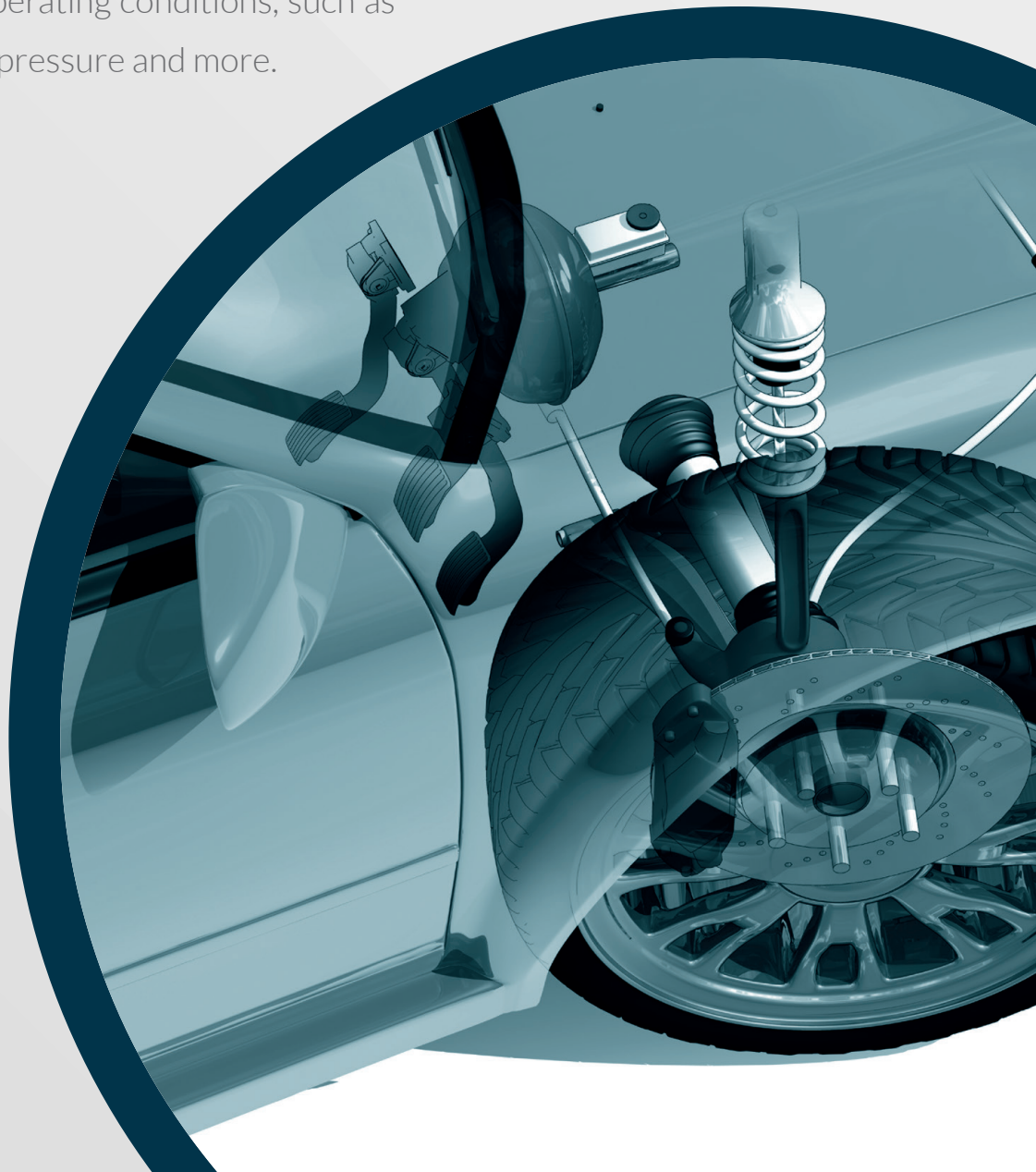



THE DETAILED SPECIFICATIONS DEFINE OPERATION UNDER ALL CONDITIONS. THIS DOCUMENT INCLUDES THE FOLLOWING ITEMS:

- Minimum and maximum limits for each function.
- Relationship between input and output.
- Functions of each pin.
- Maximum deviation.
- Operating conditions the chip must tolerate and still meet its intended function (temperature, static electricity, moisture, high voltage, short circuit, etc.)
- Number of pins.
- The mechanical dimensions of the packaged IC.
- Methods of shipment (tape on reel vs. tray packed for example).

THE ENTIRE DEVELOPMENT PROCESS IS ILLUSTRATED BY AN EXAMPLE OF A PRESSURE SENSOR CHIP FOR MEASURING PRESSURE IN THE BRAKE SYSTEM OF A CAR.

**This chip must meet the following specifications:**

- Measure pressure: 1 bar (for comparison: in a car tire pressure is about 2.2 bar).
- The relationship between the input and output (figure bottom right).
  - At 0 bar the output = 0.5 volt
  - At 50 bar the output = 4.5 volt
- Output signal should have 0.5% linearity to pressure between 0 and 50 bar.
- Chip size: 3.5 mm<sup>2</sup>.
- Number of pins = 3: 1 for VDD (supply), 1 for ground, and 1 for the output signal.
- The VDD and output pins are used to program the chip after it is in the application.
- Response time: 2 msec.
- Ambient temperature range: -40°C to 150°C.

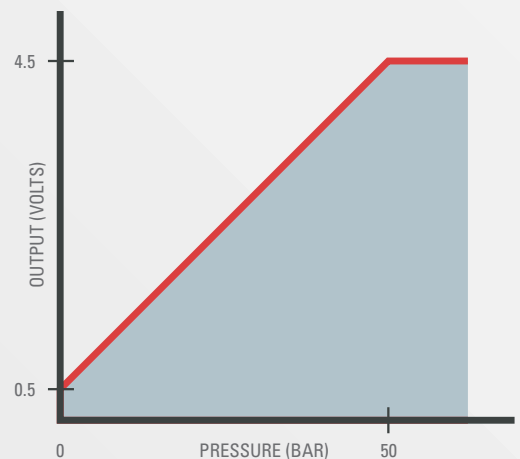
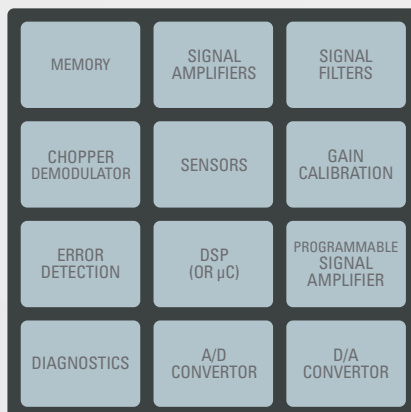



## ENGINEERING WITH A PURPOSE

Once the chip definition is complete, our systems architect develops a plan consisting of several circuit blocks, each with its own specification. These blocks are then implemented by a design engineer, who uses basic elements (transistors, resistors) to build a virtual circuit, the correct functionality of which is verified using mathematical models. Then the individual blocks are combined, in order to minimize chip area, create efficient signal paths and avoid noise and signal interference.

In each stage of this process the design team runs computer simulations to confirm the blocks work separately and together. The chip consists of tens of thousands of basic elements (resistors, capacitors, etc.) At Melexis the work is done by virtual teams spread among the design centers in Belgium, Germany, Switzerland, France, Bulgaria, Ukraine and USA.



## AN INTEGRATED PRESSURE SENSOR WOULD NEED THE FOLLOWING BLOCKS:

- **MEMS sensor element:** a microelectromechanical transducer that deflects when stressed by the pressure change of the brake fluid.  
Input = fluid pressure  
Output = a voltage signal
- **Instrumentation amplifier:** amplifies the transducer output to the desired level.  
Input = voltage signal of MEMS transducer  
Output = a voltage signal of larger span
- **Filter block:** removes noise outside the frequency ranges of interest.  
Input = voltage signal of the instrumentation amplifier  
Output = a voltage signal without noise
- **Temperature sensor:** on chip reference temperature sensor.  
Input = ambient temperature of the die  
Output = a reference voltage or current
- **Signal processor:** performs calculations using sampled values.  
Input = digitized signals of other outputs  
Output = corrected proportional signal of 0.5 and 4.5 volt or digital equivalent
- **Error detection:** monitors for fault conditions inside and outside the chip.  
Input = signals from outside or internal blocks  
Output = diagnostic voltage at output pin
- **Analog to digital converters/digital to analog converters:** measure and convert the filtered, corrected analog sensor signal. Convert the output from the signal processor back into the 0.5 to 4.5 volt final output signal.
- **Calibration method:** allows chip to be digitally calibrated for optimal performance at final test. In some cases, further calibration can be done by the end customer.

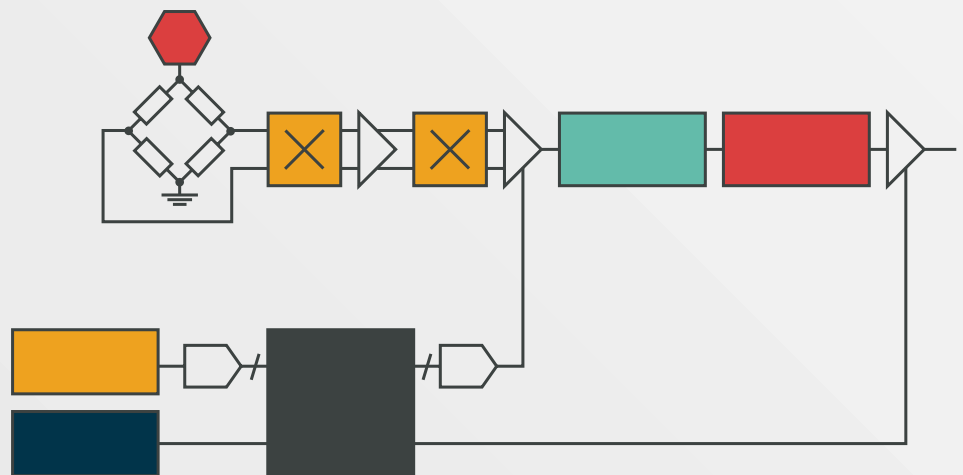

BLOCK DIAGRAM OF AN INTEGRATED MEMS PRESSURE SENSOR



03

## WELCOME TO CHIP CITY

Next, the layout engineer arranges the conceptual standard blocks into their physical locations. The resulting chip image looks like an aerial view of a city, with streets and buildings and parking lots.

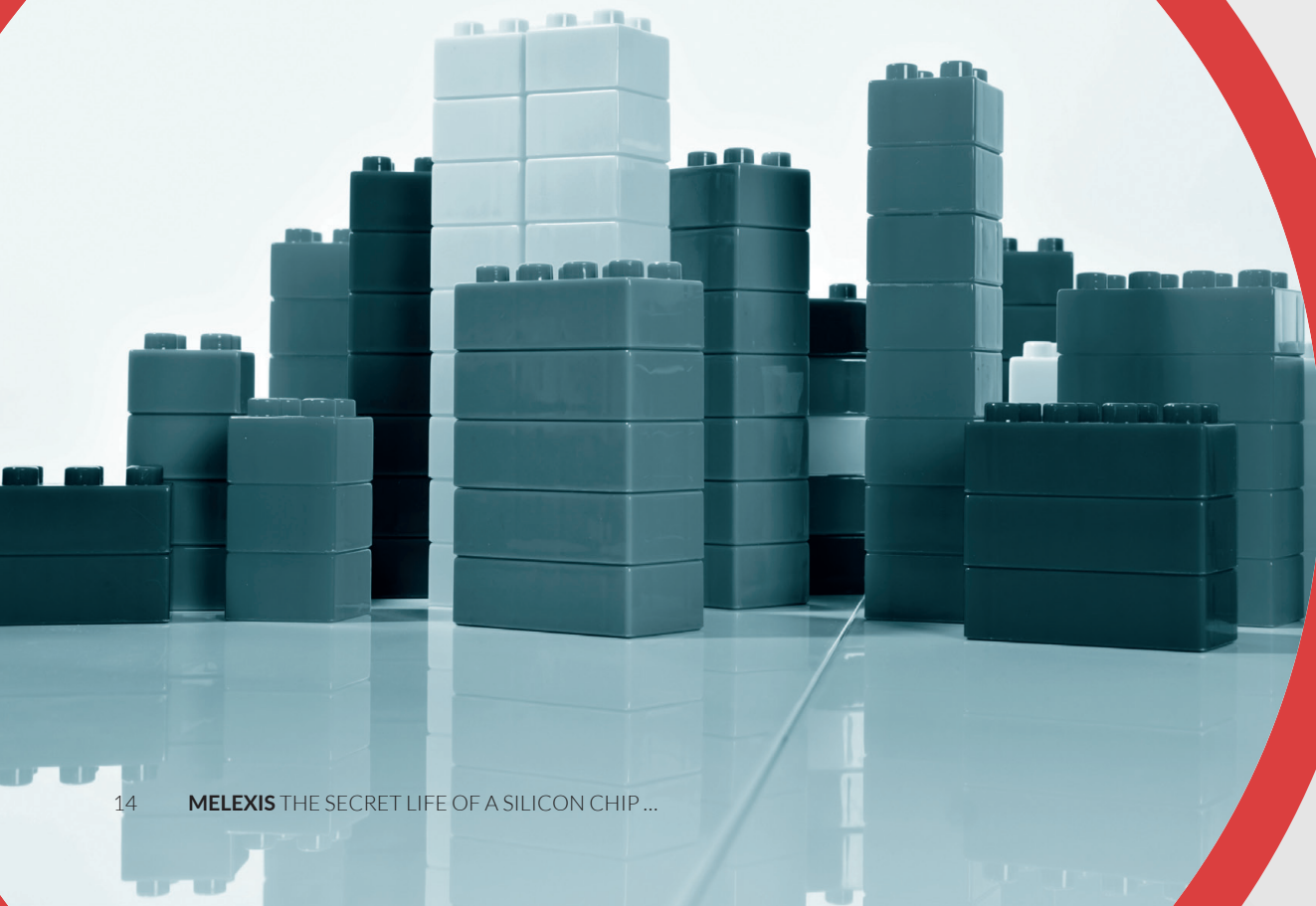

## THE PROCESS INVOLVES THE FOLLOWING:

- **Surface.** The larger the chip, the higher the fabrication cost.
- **Interference of signals** within and between certain blocks and certain signal paths.
- **Physical constraints.** Heat from some elements can wrongly influence proper operation of other blocks or elements. The MEMS transducer needs to be centered on the IC to avoid package stress and errors.
- **Efficient signal paths between blocks.**
- **Input and output.** The chosen package and the IC pin layout must allow for efficiently wiring the IC signals to the appropriate package terminals.

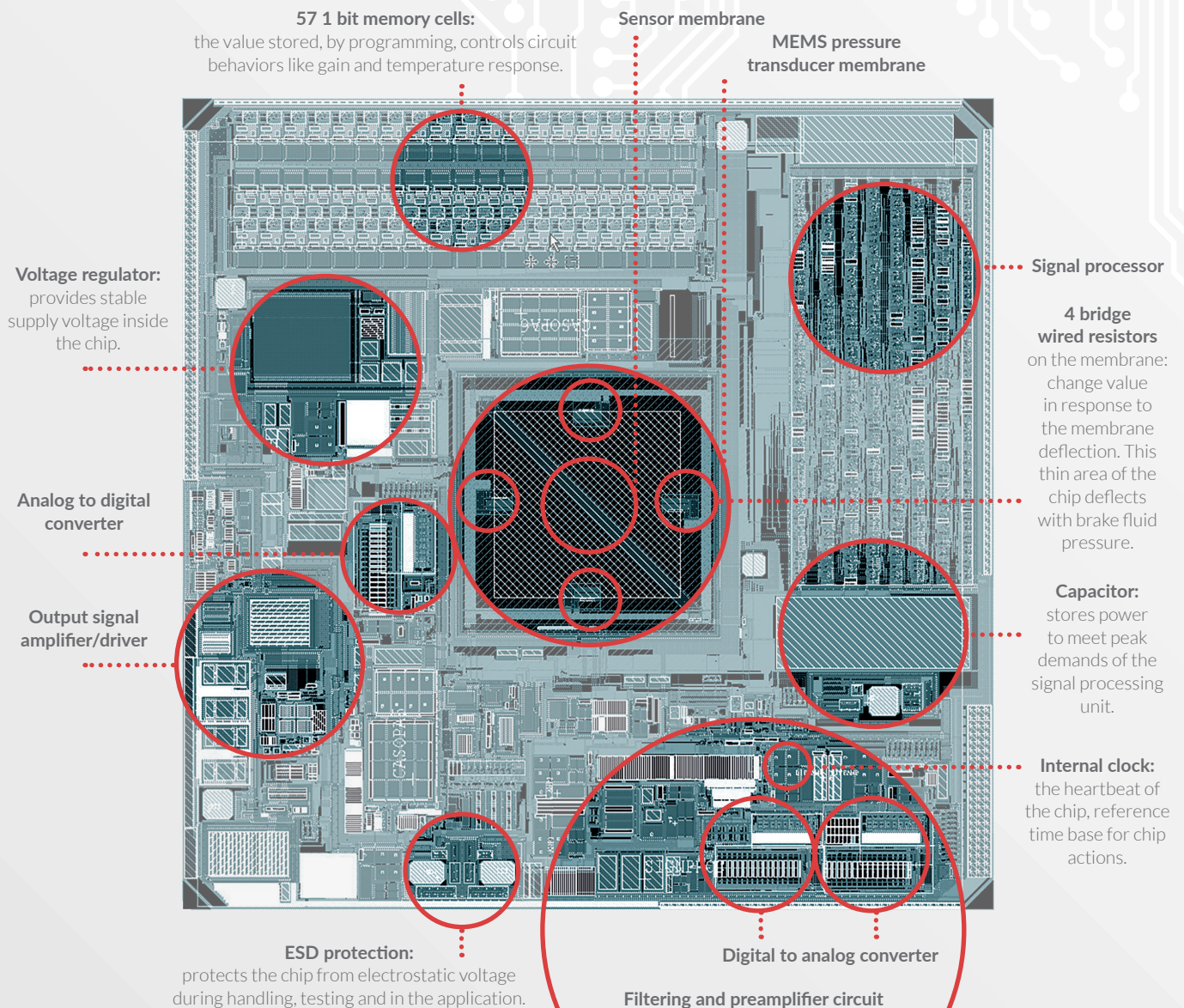



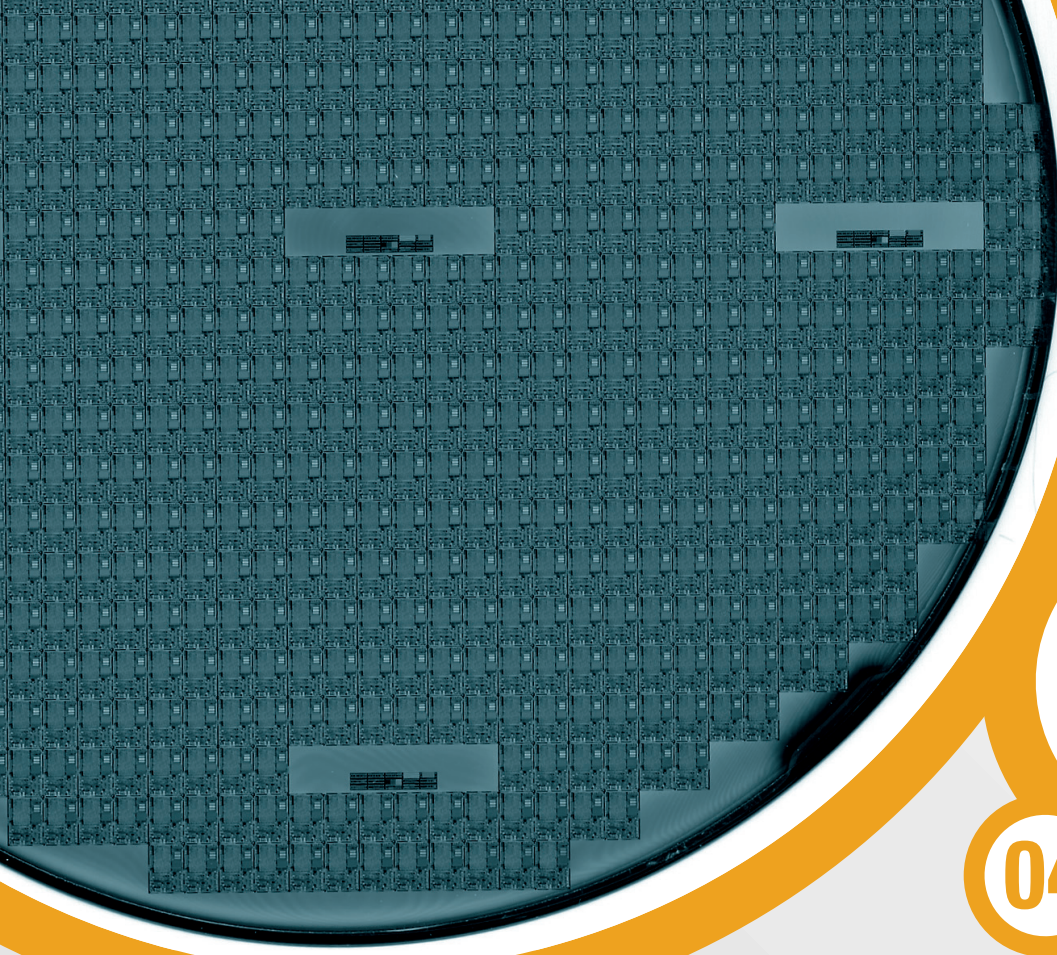

## PICTURE PERFECT

Once we are happy with the chip layout and simulation, it is time to really bring the chip to life. Copies of its layout are made on a single silicon wafer, made from pure sand (or silica). In the wafer fab, the layout is then transformed into a working chip. This is done by transferring very fine patterns on the silicon wafer through a photolithographic process.

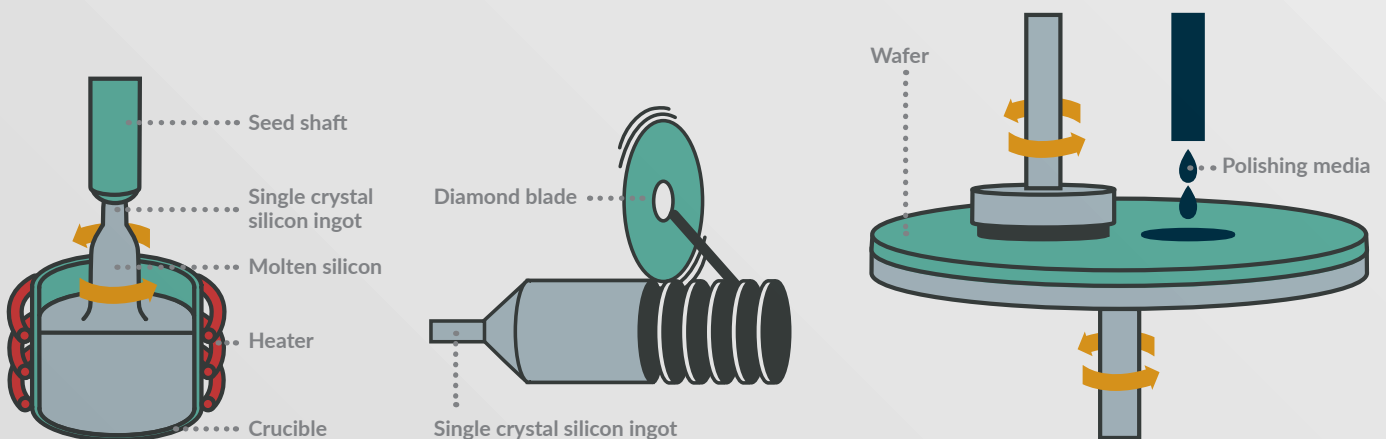



## Say what?

This is how the process works ...

### BRING ON THE MASKETEERS!

- We expose a photosensitive layer on the wafer through a glass mask which contains patterns of one layer of the chip.
- Where the photosensitive layer is exposed to the light, the layer reacts and breaks down.
- The developed photosensitive layer can then be easily dissolved and washed away.
- The silicon crystal is modified by selective contamination of small areas through the openings patterned by the lithographic process.
- This modification is done in a diffusion furnace with very high temperatures and precisely controlled chemistry. Here, the silicon is locally changed so that the electronic building blocks (transistors, capacitors, resistors and diodes) are formed.

These photolithographic steps are repeated 11 to 25 times depending on the required circuitry.

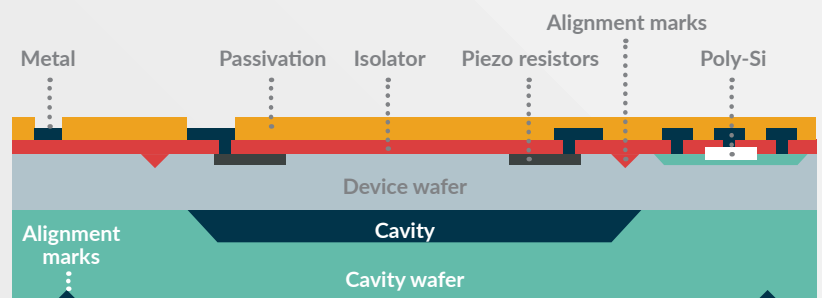
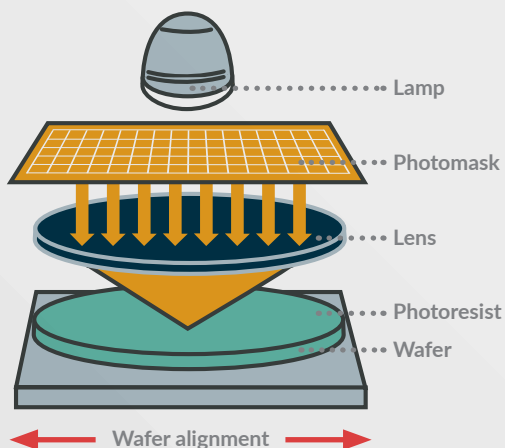

AN EXAMPLE OF THE MANY LAYERS OF A SILICON WAFER

# THE TEST OF TIME

05



After the wafer is made, it needs to be tested. Wafer testing, also known as probing, involves testing the chip with tiny needles which electrically connect each chip to the tester.





Each type of chip, (pressure, infrared sensor, etc.) requires that unique parameters be tested. The test engineer develops a specific test regime for each chip. The goal is to test, with high statistical confidence, the performance to the specifications, as quickly as possible. Chips which do not meet the limits of the test regime are marked and identified on a digital map.

The probe card electrically connects the tester to the chips on the wafer via small needles. The wafer is repeatedly shifted and sometimes several chips are tested in parallel. All test data are stored on a server.





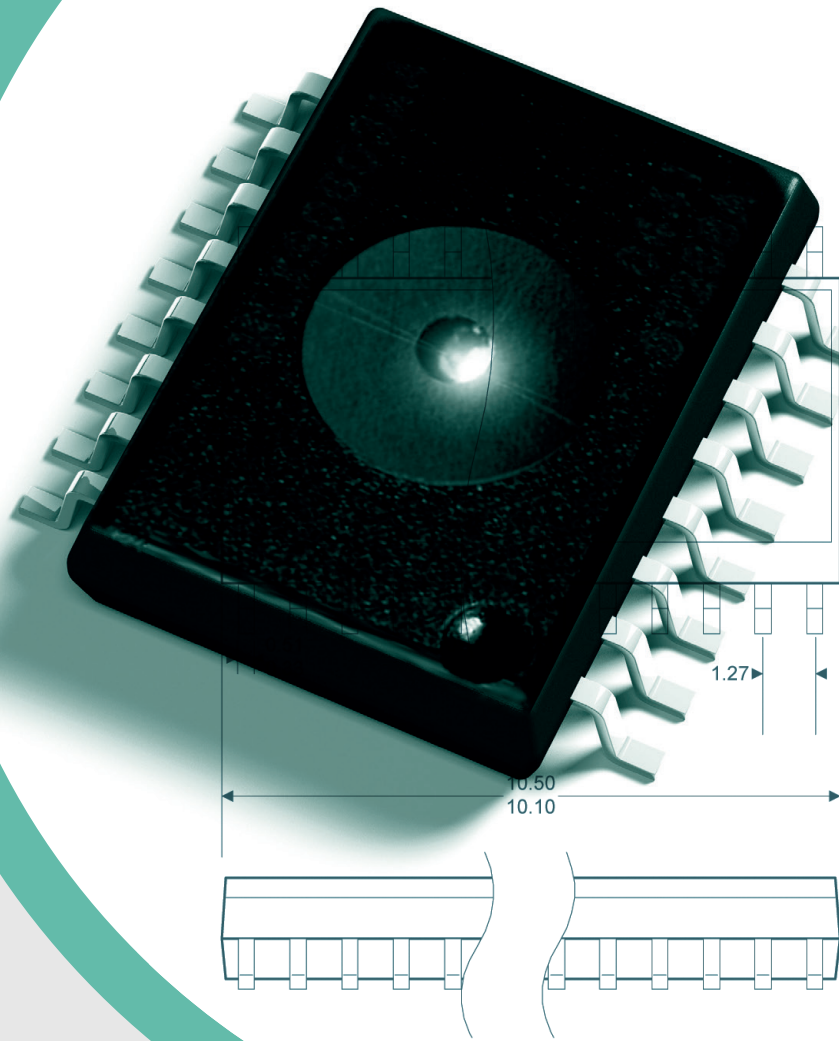

## THE TOTAL PACKAGE

Chips are made of silicon and need protection to be useful.

Not only is the chip itself delicate, but so are its fine electrical connections – called bondwire.

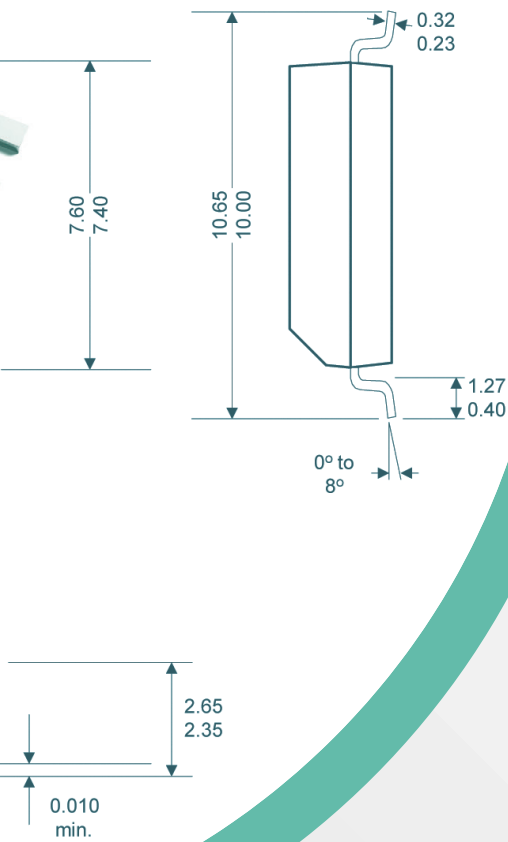

## THE TESTED WAFERS ARE SENT TO THE PACKAGE ASSEMBLY HOUSE FOR THE FINAL PHYSICAL TRANSFORMATION.

First the wafers are sawn into individual die, then the unmarked chips (good ones) are assembled into the required package. This might be a plastic package or a metal or ceramic package. The process is fully automated. Most semiconductor packaging specialists are found in the Far East.

Whereas the functioning of the silicon is mainly electrical, the package's functions are mainly physical. The package's main function is to protect the delicate silicon chip from its environment, both the chip itself and its electrical connections or bondwire.

The bondwires connect the actual chip to the pins inside the package. The package essentially becomes a "suit of armor" for the chip. Many packages are shared throughout the industry as standard packages. This provides a circuit board or module designer with some standardization - working with familiar package footprints, and possibly even pin-to-pin compatibility. Standardization makes it possible to design a brand new chip for an existing application, eliminating the need to redesign the PC board.

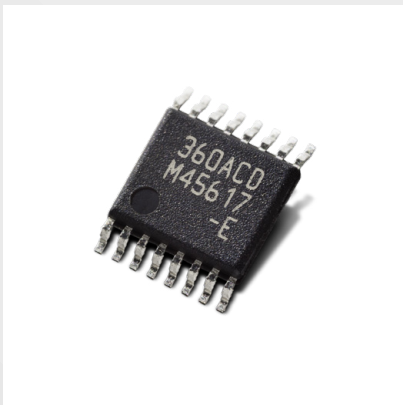

STANDARD 16-PIN  
SOIC PACKAGE

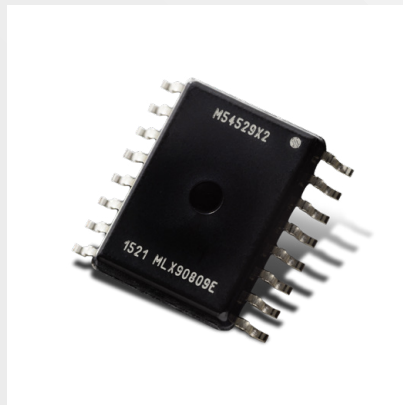

MODIFIED SOIC PACKAGE WITH PORTAL FOR  
SENSING PRESSURE



METAL "CAN" PACKAGE WITH APERTURE FOR  
SENSING INFRA-RED



# THE FINAL COUNTDOWN

Now the packaged chips are shipped back to Melexis. Each chip is tested with a similar testing regime as the wafer test (see step 5), but this time at three different temperatures:  $-40^{\circ}\text{C}$ ,  $25^{\circ}\text{C}$  and  $135^{\circ}\text{C}$ .





The photo on the left side shows a testing machine that moves the chips from carrier tubes at the top tray, through 3 climate chambers where chips are heated or cooled and electrical tests applied. During calibration, the sensor adjustments are programmed based on the measurements of the three different steps. The test results are assessed and the good chips are deposited into carrier tubes at the bottom. The chips that fail the tests will be automatically removed.

Of the chips that have passed the temperature testing, a few samples are periodically selected and tested again. When this test is successful, the chips in the entire test lot are packed and shipped to customers. These customers are often automotive suppliers making crucial electronics found in your new car.

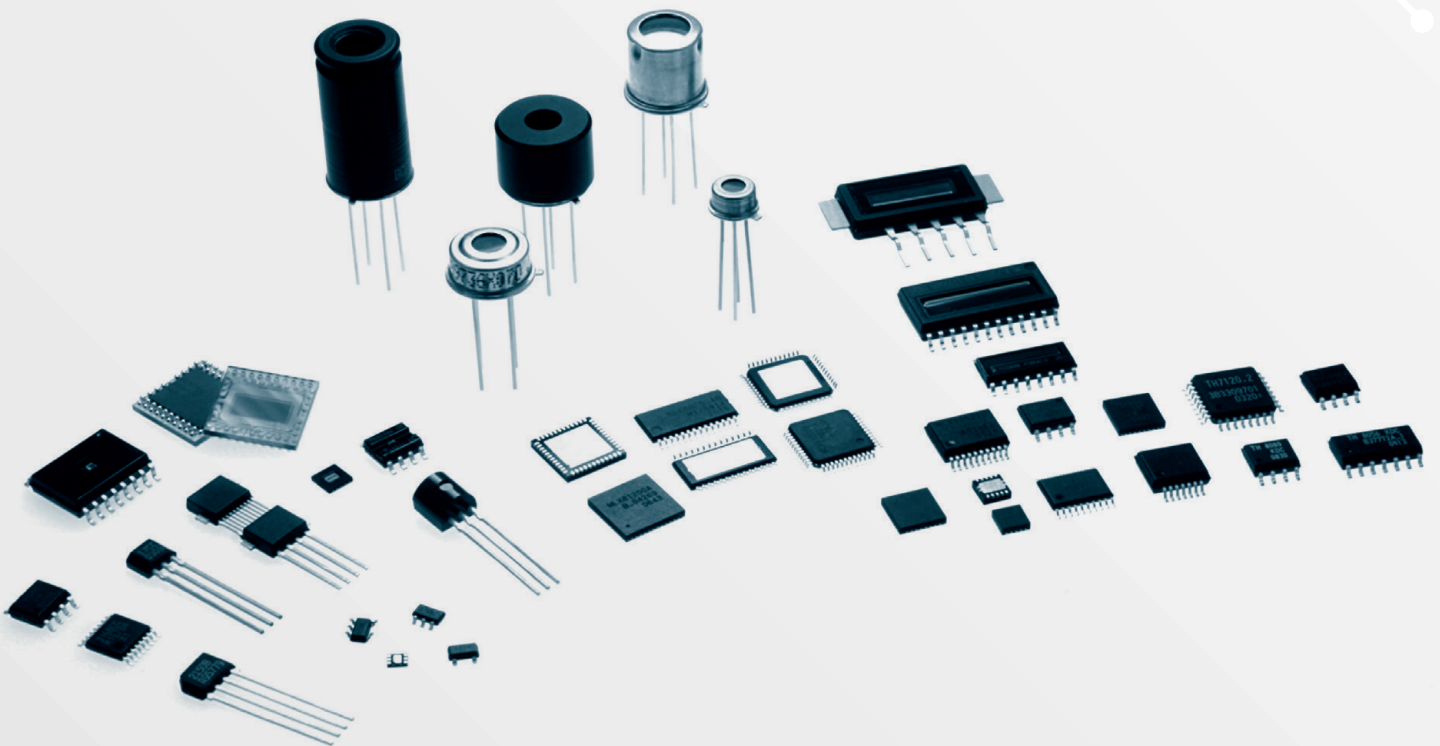



## ONE FOR THE ROAD

The chip of this story will detect brake pressure and communicate the status of your critical anti-lock brake system to the controller. These data may be shared over the network with the electronic stability control system to help prevent skidding and rollover.

Other chips have their own story to live. Melexis makes many chips to measure the real world and report accurately what is happening to a controller.

Higher levels of integration can bring more cost effective solutions to bear on the evolving automotive electronics challenges. For example, Melexis can deliver a fully integrated device to drive all sorts of electrical pumps like water, oil or gasoline pumps. The Melexis Trusense® technology combines reluctance measurements with BEMF (Back Electro-Motive Force) sensing, yielding highly accurate rotor position information in a very wide dynamic range and under heavily changing loads.

Such technology is critical in today's Start/Stop systems. Shutting down the engine when a car stops to prevent idling improves the fuel economy and reduces emissions significantly. The engineering challenge is to have all systems in the car at full force a millisecond after the driver depresses the accelerator pedal to once again be in motion. These chips truly bring the electronics revolution right to your door, your car - that is. The benefits are incalculable, from lives directly saved by safety systems to the inestimable effects of reducing greenhouse gas emissions.

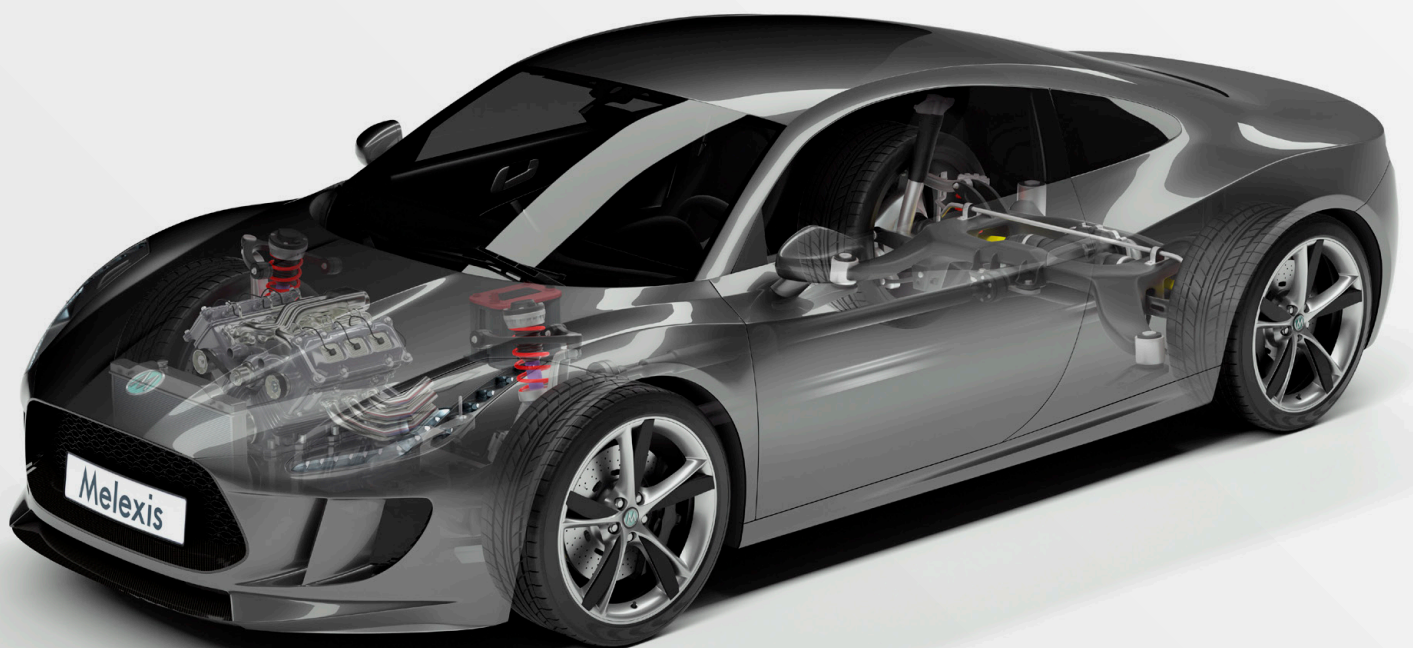



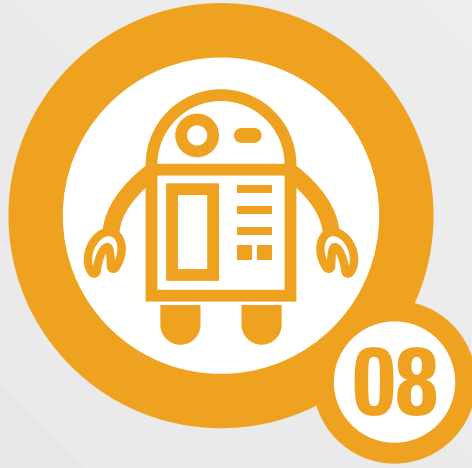

# A SENSE OF THINGS TO COME

Imagine a world in which your self-driving car greets you in the morning. You unplug it from the smart grid and off you go! The inside of the car is very comfortable: as you work on your laptop, or simply relax and catch up on the latest news by swiping through the articles, the interior lighting adjusts automatically. Of course, you arrive at your destination right on time, since there is hardly any congestion. You don't even need to search for a parking spot! Your car simply parks itself.

Sounds like science fiction? Not really! At Melexis, we're working to create that kind of future. A clean, classy and comfortable future. Especially in terms of proximity detection and gesture recognition. Melexis offers state-of-the-art technologies like Light Detection and Ranging (LiDAR), ultrasonic sensors and Time-of-Flight (ToF) – three technologies that will play a critical role in turning the autonomous car of the future into a reality.

## THE SAGA CONTINUES

In a world where the pace of automation is accelerating, Melexis' chips are no longer just for the road. Sensors and integrated circuits (ICs) are also increasingly finding their way into manufacturing applications and consumer goods. Melexis' Triaxis® position sensing is already used in drones, for example, and our Infrared temperature imaging is a useful tool for preventive maintenance and intervention.

Taking into account the further advancements in autonomous cars, the increased electrification of vehicles and the rapid growth of robotization and automation, the story of the silicon chip is far from over. If you would like more details about sensors and ICs or if you have specific questions, please contact us. We hope that whenever you think of silicon chips or IC technology, you will think of Melexis.

[www.melexis.com](http://www.melexis.com)

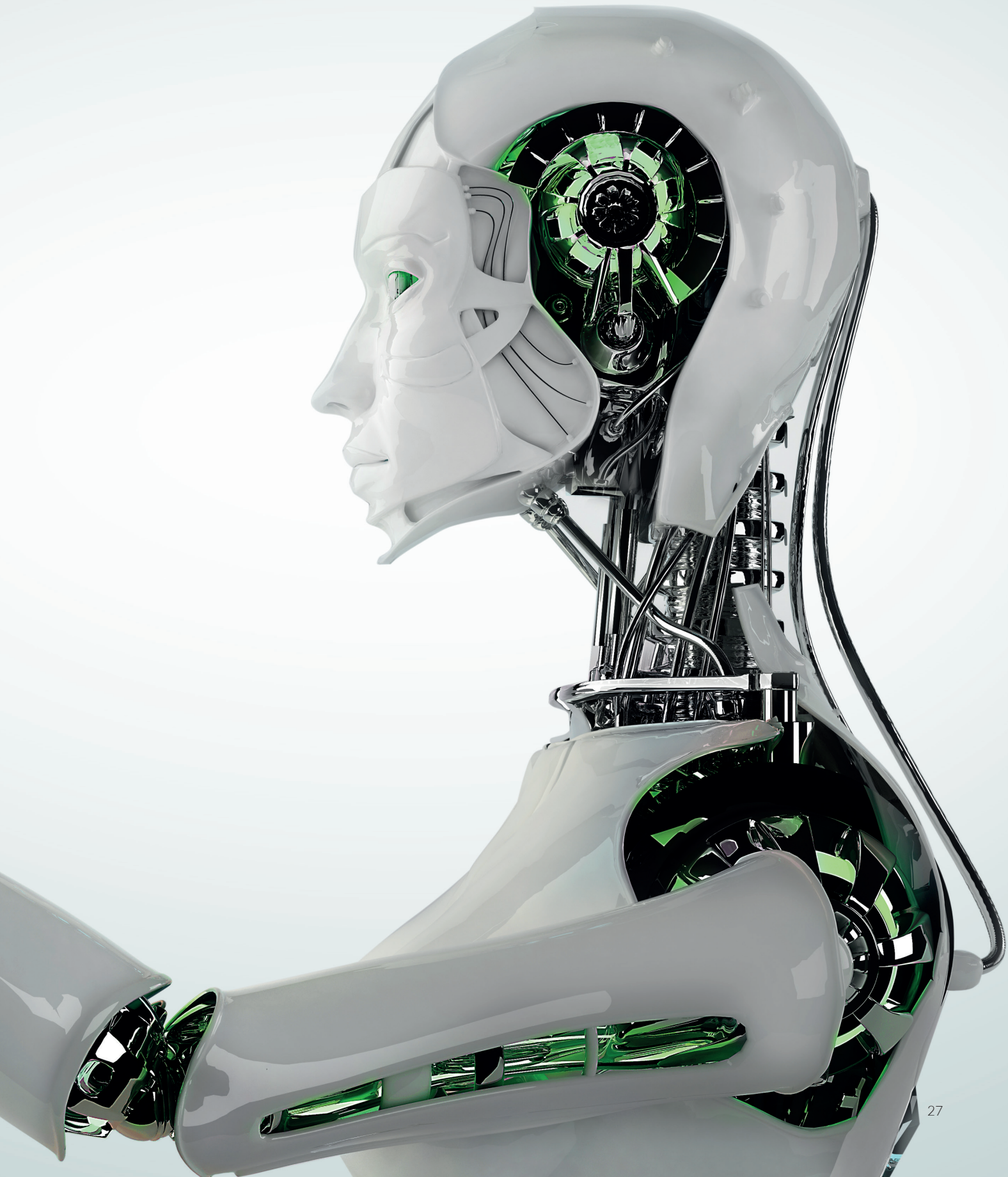

# Melexis

INSPIRED ENGINEERING

## Europe, Middle East and Africa

sales\_europe@melexis.com

Tel. +32 13 67 04 95

## Asia, Oceania

sales\_asia@melexis.com

Tel. +86 21 5820 6899

## Americas

sales\_usa@melexis.com

Tel. +1 248 306 5400

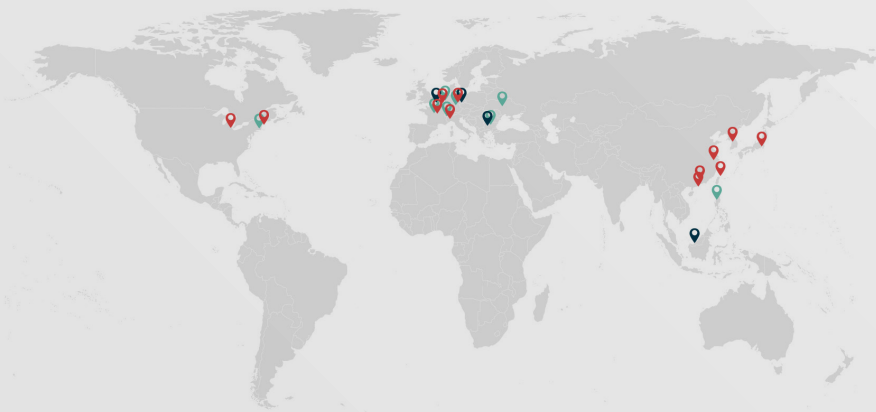

 Research & Development

 Sales & Applications

 Manufacturing



[WWW.MELEXIS.COM](http://WWW.MELEXIS.COM)