



Automotive



Alternative
mobility



Smart appliances



Smart buildings



Robotics



Energy
management



Digital health

Melexis
SENSOR ICs

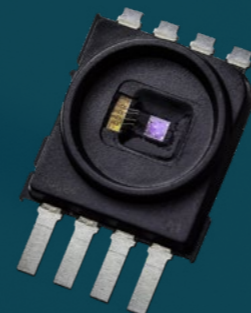
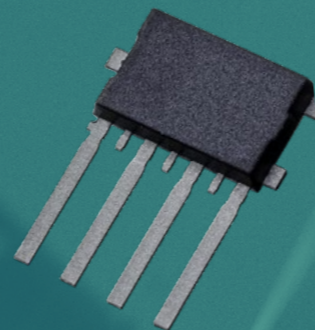
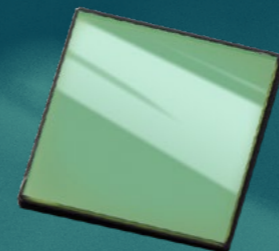
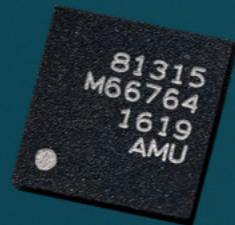
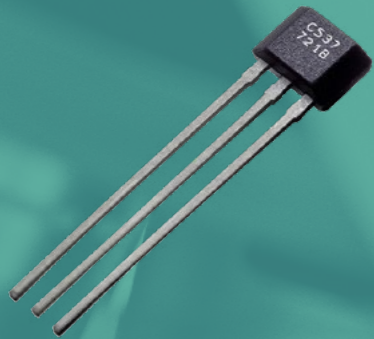

INSPIRED ENGINEERING

Each new car produced today,
wherever in the world, contains
an average of **18+ Melexis chips**.

(2023)

At Melexis, we are all about inspired engineering. Our passion for technology has made us one of the world leaders in semiconductor sensor ICs. Our sensors, drivers and transceivers enable innovation.

We play a leading role in developing new products and we keep a close eye on the rapidly evolving needs of the industry. For example, we are pioneers in 3D magnetic Hall effect sensor ICs, latch and switch ICs, and ambient lighting ICs.

Melexis has a well-matched team of experienced people. Their expertise in product definition, design and testing of integrated semiconductor solutions has placed Melexis at the forefront of the industry.

Automotive: page 6 - 27

All markets: page 28 - 43

OUR STRATEGY

Customer focus and a consistent strategic vision are the basis of Melexis' growth journey.

We create innovative and compelling products in response to industry and customer preferences. We combine this with a timely and reliable production process. This is essential to our success and of our customers.

A mix of team spirit, a shared set of core values and a no-nonsense culture empower our people to offer high-quality, leading technological solutions to customers. We continuously build on our knowledge and experience, expanding our scope to include new applications and new sectors.



With the increased number of sensors and drivers per application, reliability becomes critical. Throughout the entire lifecycle of our products, we therefore ensure competitive processes that continuously reduce incidents.



Melexis sensor ICs are part of our ASIL-ready program and contain a suite of on-board diagnostics to ensure safe and correct operation. Melexis can provide additional supporting documentation (Safety Manual) to conduct the necessary safety analysis to ensure ASIL/ISO26262 requirements are met.



SUSTAINABILITY AT HEART

We care about people

Since 1989, Melexis has grown into a company with more than 1,700 colleagues on three continents. Our company combines exceptional people with a unique company culture, great products and a promising future. Melexis is committed to promoting gender equality throughout our entire organization. A shared corporate vision enables our growth and our people represent a vital link in the chain that connects motivated individuals, outstanding teams and great results.

We care about the planet

Melexis is acutely aware of the increasing worldwide concern for safety and sustainability, two areas in which we have been active for many years. From sensors and sensor interfaces to embedded and smart drivers, we are constantly innovating to help create the most sustainable and reliable solutions possible. Our quality and environmental policy is the guiding principle throughout our organization and strives to keep our environmental footprint as small as possible.

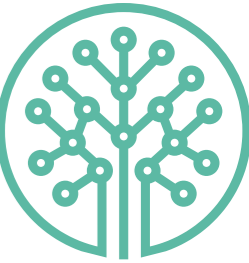

Melexis
SUSTAINABILITY

SENSE & DRIVE

- 1
Magnetic position sensor ICs
P 8

Effective, accurate and reliable position sensing
- 2
Current sensor ICs
P 10

Ideal for innovative applications in the fast-growing market for the electrification
- 3
Latch & switch ICs
P 12

Latch and switch devices detect the proximity of a magnet
- 4
Embedded motor driver ICs
P 14

Drive electric motors with and without sensor in the most silent and efficient way
- 5
Smart driver ICs
P 16

Cost optimized smart drivers for fans & pumps solutions
- 6
Inductive position sensor ICs
P 16

Effective, accurate and reliable position sensing



CUSTOMER-DRIVEN INNOVATION
WE ENABLE EDGE SENSING AND EDGE DRIVING
 As a fabless semiconductor company, we engineer smart sensing and driving nodes that are used in a variety of applications. Our ICs communicate with the outside world and combine analog and digital signals.



SENSE & LIGHT

- 7
Pressure sensor ICs
P 18

Plug-and-play solutions for pressure sensing
- 8
Temperature sensor ICs
P 20

Contactless FIR temperature sensing (single pixel and array)
- 9
Embedded lighting ICs
P 21

Our smart LED drivers enable sophisticated yet cost-effective ambient lighting for vehicles
- 10
Optical sensor ICs
P 22

Time of flight, light and rain light sensors



1 MAGNETIC POSITION SENSOR ICs

Effective, accurate and reliable position sensing is essential to the modern vehicle. Our Triaxis® technology, based on magnetic contactless sensing, allows engineers to solve design challenges in automotive applications.

Triaxis® technology

Triaxis® is an innovative magnetic sensor technology capable of very precise three-axis magnetic field measurements (Bx, By and Bz) from a single sensor IC. The sensors can detect rotary, linear or joystick-type motion. The technology enable the use of smaller and lower-cost magnets. This makes our sensors perfect for elegant solutions in space and cost constrained automotive applications.

Stray field immunity

One of the critical challenges in electric vehicle applications is the high levels of stray magnetic fields. By measuring a magnetic field gradient, our magnetic sensor ICs can be intrinsically insensitive to stray fields up to 4 kA/m or 5 mT (ISO 11452-8), which meets the needs of most automotive applications.



- Output: analog, PWM, SENT, PS15, SPI, I2C
- Package: Surface mount and PCB-less packages with single and dual die options
- ASIL-C (D) (certified by SGS-TÜV acc. ISO26262)
- Stray field immunity (up to 4000 A/m acc. ISO11452-8)
- EMC robustness (transient, immunity, emission)
- High accuracy:
 - Low thermal drift
 - Low noise

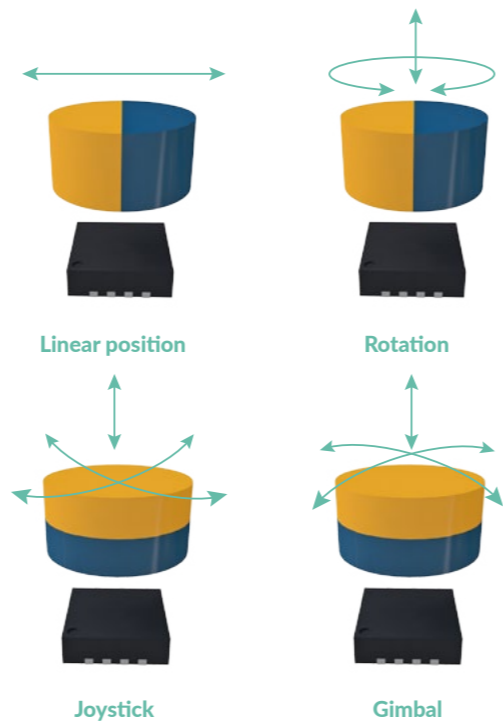

1+ BILLION SENSOR ICs SHIPPED

Triaxis® has grown into a complete family of products covering the needs of position sensing applications in automotive and industrial products. This is an achievement we are very proud of.



MAGNETIC POSITION SENSOR ICs MELEXIS IC SOLUTIONS IN YOUR APPLICATION

- Manifold flap actuator
- Turbo wastegate actuator
- Electric throttle body
- Exhaust gas recirculation valve
- Steering angle sensor
- Shifter (PRDNL) position
- Fuel level sensor
- Variable valve actuator sensor
- Coolant valve
- Transmission sensor - fork, clutch, ETRS
- Variable geometry turbo actuator
- Human machine interfaces, e.g. headlamp switch
- Pedals - accelerator, brake, clutch
- Ride height sensor

PEDALS

Contactless position sensing for all pedal applications. From classic three pedals to one pedal drive.

RIDE HEIGHT

Fast rotary motion sensing to ensure comfort and safety functions for all road conditions.

ELECTRIC POWER STEERING

Accurate sensing of the steering angle and torque. Essential for safety features such as Electronic Stability Control (ESC).

GEAR SHIFTER

Reliable position sensing. A next step towards drive-by-wire.

SOIC-8, TSSOP-16, DMP-4 and SMP-4 packages

2 CURRENT SENSOR ICs

Our Hall-effect current sensors offer significant performance enhancements and a rugged design. It makes them ideal for demanding applications found in the fast-growing EV market.

The IMC-Hall® technology

has found its way into battery monitoring applications at first. In recent years its deployment as a primary sensor in inverter and converter applications has been massive. Also the growing demand for ASIL in BMS systems with Li-ion chemistry, has led to substantial demand increase given the need for a (heterogenous) redundant sensing solution next to shunts. The IMC-Hall® technology is now the preferred solution for many designers. It provides denser power electronics and a more flexible and lighter integration of the mechanical components with system cost reductions altogether.

The Conventional Hall technology

has been around for decades and remains a solution for current sensing. It consists of a sensor IC combined with a ferromagnetic concentrator. This concentrator increases the flux density seen by the sensor and also provides attenuation of the possible external magnetic field influences.

Integrated solution

are Hall-effect sensors with integrated current conductor and built-in stray field immunity for currents up to 50-100 A. The sensors ensure voltage isolation. They are qualified for use in a range of automotive and industrial applications, such as on-board chargers (OBC), DC/DC converters, power supplies, and small electric drives.

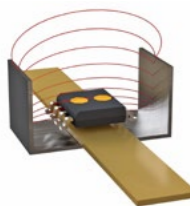

48 V DCAC INVERTER

Different architectures exist using 48 V inverters, extending from P0 architecture on the belt (iBSG) gradually shifting along the driveshaft towards a standalone e-axle P4 architecture. These starter generators enable parts or all of the following functions:

- Start
- Boost
- Charge
- Coast



THERMAL MANAGEMENT

In order to optimize energy while increasing the All-Electric Range (AER), a perfect thermal management system is key. Ideal performance of the battery requires a temperature between 15-35°C, no matter the external conditions. Without the heat source of a classical ICE, new sources for heating & cooling need to be optimized.

SEVERAL TRIM & FORM OPTIONS AVAILABLE



HORIZONTAL SMD

VERTICAL SMD

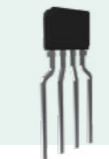

LEAD SPREADING

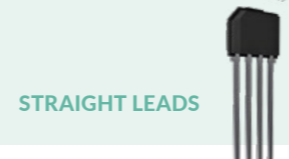

STRAIGHT LEADS

Current sensor ICs

MELEXIS IC SOLUTIONS IN YOUR APPLICATION

ON-BOARD CHARGER

Every PHEV and EV needs an on-board charger. It converts the external source (e.g. AC from the grid or DC from a fast charger) to the right DC voltage compatible with the battery of the vehicle. Several current sensors are needed in the conversion chain, both AC and DC. Such a chain consist of an EMI filter, a PFC, an inverter, a transformer and finally a rectifier.

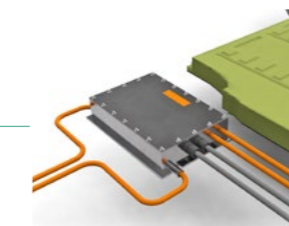

DCDC CONVERTER

EVs architecture can requires different voltages, depending on the supported applications (12 V, 48 V, 400 V, 800 V etc.). The electrical conversion between board nets is therefore important. This is the role of a DCDC converter. It consist of a high side and a low side - which typically support a higher current in the range of 200 A or more. Complex DCDC converter enable bi-directional conversion.

DCAC INVERTER

The conversion from DC battery voltage to AC motor control requires an inverter. The inverter consists of high power transistors in the power module that will switch between the battery voltage rails to generate the 3 phases that will drive the motor. The phase currents need to be monitored accurately and even the DC link itself is regularly monitored too. The objective is to have proper motor control and torque control, with detection of anomalies or faults as well.

48 V AND HV BATTERY

A high power battery can be found in EV or PHEV. Due to the high currents in this applications, a contactless sensing technology lends itself very well to such current measurement. BMS (Battery Management System) is one of the decisive elements for the EV performance.

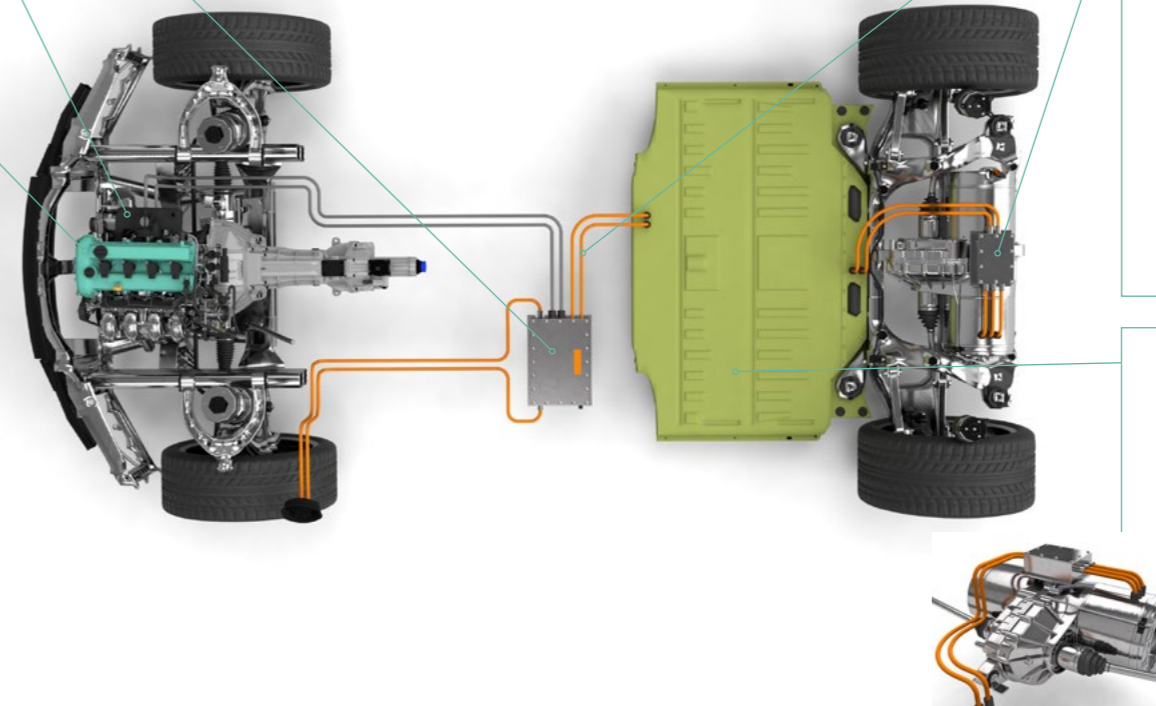

3 LATCH & SWITCH ICs



Latch and switch devices rely on the principles of the Hall-effect to, through the position of a magnet, determine the physical position of an object. These on-off switching devices are very common in automotive applications such as braking, shifter applications, doorlocks or seatbelts.

Compact module designs

Melexis' Latch & Switch sensors use an innovative magnetic technology that allows the measurement of the lateral magnetic flux component. The lateral sensing devices (MLX92232, MLX92292, MLX92362) are commonly used in automotive applications such as transmission selectors (gear shifts) and HMI interfaces. Thanks to their integrated magnetic concentrator (IMC), they allow the magnet to be placed beside the sensor, thereby saving space and enabling new applications where previously there was not enough room for a magnetic sensing solution.

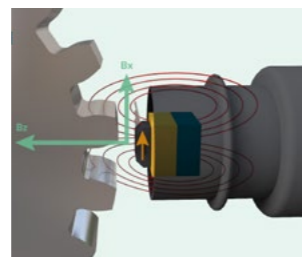

Back-biased applications

speed sensing with a simple switch

As a result of the inclusion of IMC technology, simple wheel speed sensing on motorcycles can now be performed using a single two-wire switch sensor with integrated capacitor (MLX92242 or MLX92241) and a traditional magnet. This approach uses the lateral field instead of the perpendicular field, thus vastly simplifying the designer's task.

- 2-, 3- and 4-wire latch and/or switches
- Single and dual die
- Micro-power
- ISO26262 (ASIL-B)
- Pre-programmed and programmable (EEPROM)
- ESD & EMC robust
- IMC-Hall® for lateral sensing solution
- PCB-less option with integrated cap in UA-package



3+ BILLION SENSOR ICs SHIPPED

In 2022, the 3 billionth Melexis Latch & Switch sensor IC has been shipped. This milestone wouldn't have been reached without our internal dedicated teams, our broad partner base, operational activities in development, worldwide footprint, and last but definitely not least, our customers who pushed us to where we are today.

LATCH & SWITCH ICs

MELEXIS IC SOLUTIONS IN YOUR APPLICATION



WINDOW LIFTER - SUNROOF

Power windows enable convenience features like automatically raising or lowering the window ("one-touch" operation) thus allowing the driver to maintain focus on controlling the vehicle.

SEAT BELT BUCKLE

A rightly latched seat belt buckle ensures the vehicle occupant is properly restrained in case of an accident or sudden stop.



SPEED SENSING

Wheel speed provides speed information from the wheels to the ECU with a simplified design using a standard back biased magnet.

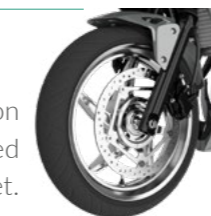

SEAT POSITION MOTOR

Accurate detection of the seat position can be used by ECUs to adjust safety features such as air bag deployment or seatbelt tensioning.



PTC-04

The PTC-04 programmer is designed for efficient and precise calibration of Melexis ICs. It can be easily adapted to a standard PC and to an application module to allow calibration of programmable sensor ICs within the operating environment.

The PTC-04 contains its own programmable power supply, measurement circuitry, dedicated features (such as 16-bit voltage and current measurement capability) and a configuration option that will accommodate users from the prototyping phase directly into production. IC based hardware and a PC are required to load software to the programmer and control the functions of the programmer. Consult us for more information.

4 EMBEDDED MOTOR DRIVER ICs

Melexis develops smart LIN motor drivers and pre-drivers for motor currents from 0.1 A to 100 A. These ICs embed a custom software to drive your BLDC, DC and stepper motors. They enable small footprint for 12, 24 or 48 V applications. These solutions drive the electric motor with or without (position) sensor in the most silent and efficient way, which makes them an excellent choice for electric cars. The ICs have a digital LIN interface for commands and feedback to enable digital motion control by the car ECU. The LIN interface is compliant with LIN1.x, LIN2.x, SAE J2602, and can be configured for PWM communication. Optimize your automotive mechatronic applications now.

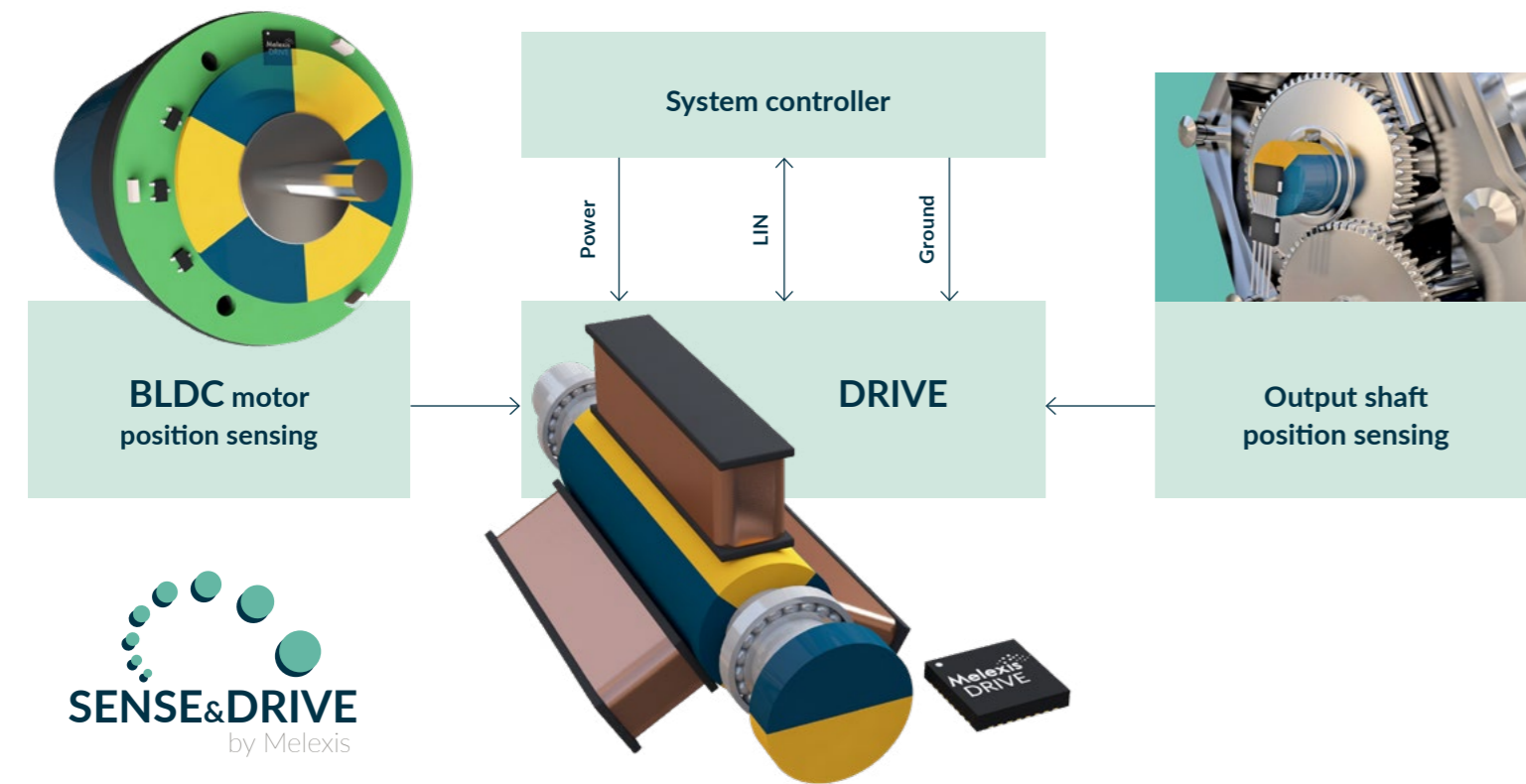

ENABLING SMART & SMALL, PLUG & PLAY MECHATRONICS

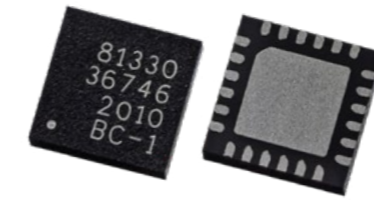

LIN MOTOR DRIVER
 Smart LIN driver for DC, stepper, BLDC motors.
 <1 A motor current

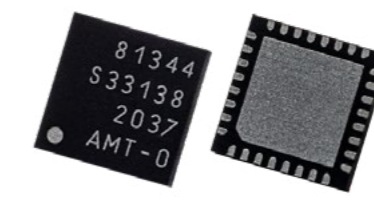

LIN MOTOR PRE-DRIVER
 Smart LIN pre-driver for DC, stepper, BLDC motors.
 >1 A motor current

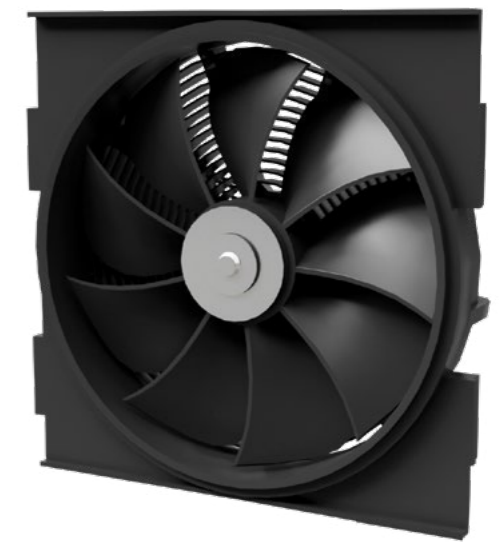

<10 W

- Adaptive frontlight system
- Grille shutter
- HVAC flap
- Seat fans

<100 W

- Smart valve
- Small waterpump
- 3 phase fan

>100 W

- HVAC blower
- Engine cooling fan
- Pumps
- Window lift, sunroof



5 SMART DRIVER ICs

Enabling cost-optimized, minimum-size and whisper-silent cooling solutions for automotive and consumer applications.

BROAD PORTFOLIO

- From 0.1 W to 40 W
- From 5V to 32 V
- 1-coil
- Fans and pumps

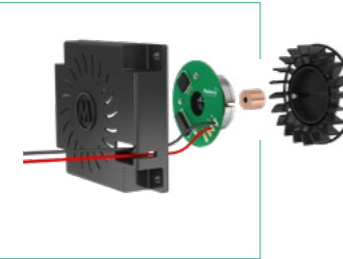

FANS/PUMPS

- CPU/GPU cooling
- Seat ventilation
- Air quality sensor
- Battery cooling
- LED headlamps
- Cell phone wireless charger

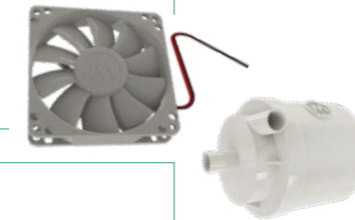

UNIQUE AREAS OF EXPERTISE

- Optimized for low acoustic noise operation, and/or maximum torque
- Plug-and-play, no software development
- High quality at low cost
- High robustness against EOS (Electrical Over Stress)
- Extensive protection (LRP, OV, UV, OC, OT)
- AECQ100 compliant packages with very small footprint



6 INDUCTIVE POSITION SENSOR ICs

Inductive position sensors are used in applications that require very high position sensing accuracy under the harshest condition of magnetic strayfields and temperature.

ABSOLUTE ROTARY POSITION SENSING

- Resolver with differential sine and cosine outputs
- Through-shaft, end-of-shaft or side-of-shaft operation

UNIQUE AREAS OF EXPERTISE

- ASIL C on component level
- ASIL C/D support at systemlevel by using redundant devices
- Stray field immunity
- High accuracy
- Low thermal drift
- High temperature operation
- EMC robustness (transient, immunity, emission)
- Application support including coil design

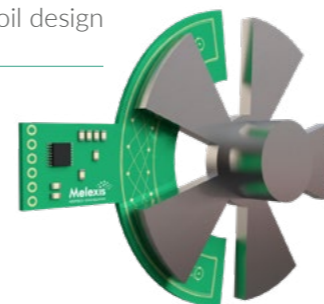

HIGH SPEED SENSING

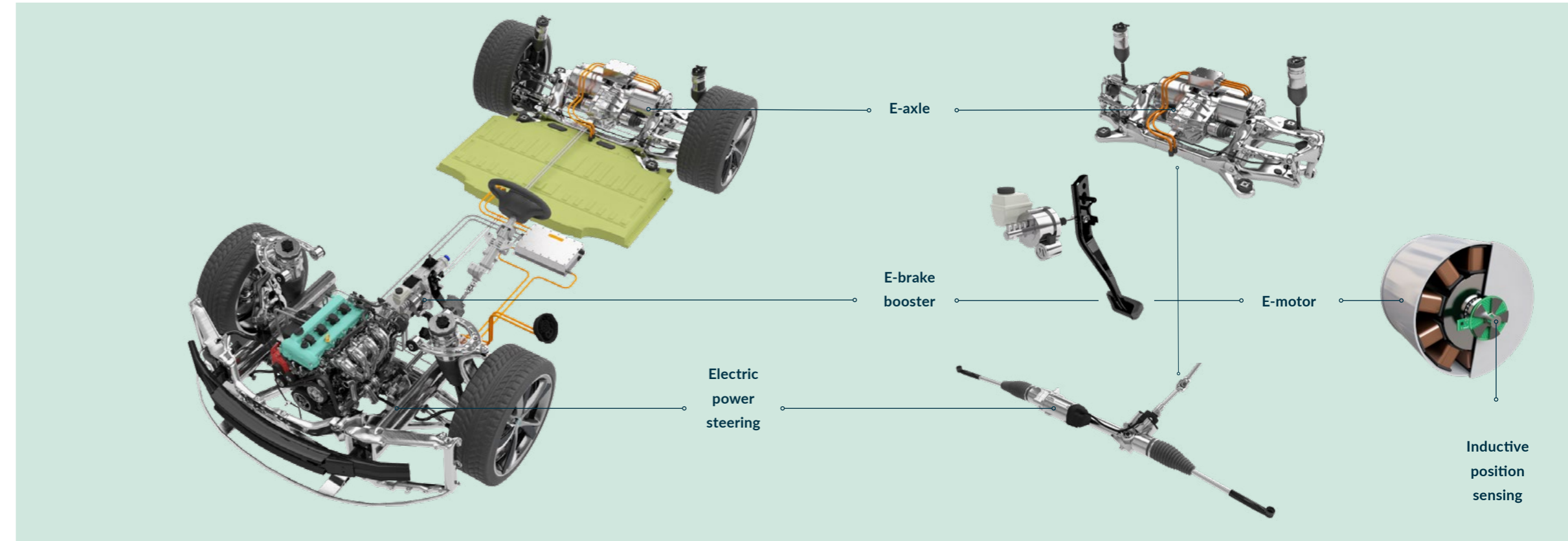

7 PRESSURE SENSOR ICs

The royalty of MEMS. We are unique and leading automotive pressure sensor market segments. Our experience is consolidated in our advanced technologies: MEMS, signal conditioning, factory calibration, packaged or not, PCB-less... Absolute or relative measurement from low to high pressure applications. When you are looking for plug-and-play solutions with the best-in-class robustness and performances in demanding harsh automotive environments you've found your partner of choice.



MLX90809 MLX90818
KINGDOM OF MEMS

LOW 0.1 - 5 bar

TMAP, CNG/LPG, VBS, FVPS, crankcase, GPF, etc.



MLX90819 MLX90329
MEMS VS. CERAMIC

MID 5 - 70 bar

HVAC, transmission/engine oil, etc.



MLX90329
INTERFACES

HIGH 70+ bar

Common rail, brake fluid, GDI, etc.

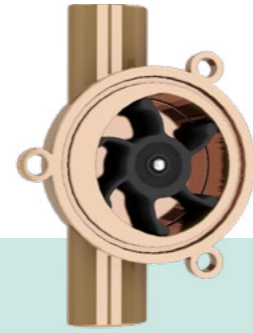

Our pressure sensors can successfully be integrated in active pumps together with Melexis motor drivers and magnetic position sensors.

FUEL VAPOR

The evaporative emissions control systems (EVAP) capture unburned fuel vapors from the fuel tank and reintroduce them into the fuel system. The pressure sensor detects the pressure in the fuel system in order to identify leaks and defective gas caps.



LUMBAR PRESSURE

Pressure sensors are regularly used to monitor the pressure of the air bladders in each individual car seat. 2 main implementations exist:

- 1 relative pressure sensor per seat that measures the pressure difference
- Between the air bladder and the cabin ambient pressure.
- Several absolute pressure sensors per seat up to one per air bladder.



PRESSURE SENSOR ICs

MELEXIS IC SOLUTIONS IN YOUR APPLICATION

TIRE MONITORING SENSOR ICs

Melexis smart tire sensor is the most fully featured, ultra-low power tire pressure measurement system (TPMS) solutions available today. They integrate all the electronic sub-systems required to develop a high performance TPMS with a minimum of external components. Pressure and acceleration sensors, an LF transceiver and RF transmitter circuits combine with a low power MLX16 RISC microcontroller in a single tiny form factor. They can be powered from typical small Lithium button cells such as CR2032/CR1632 types.

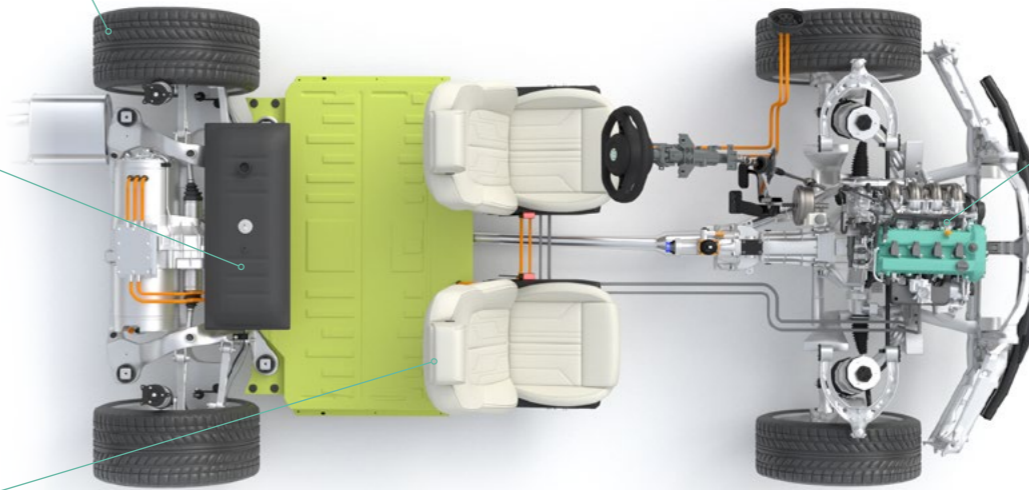
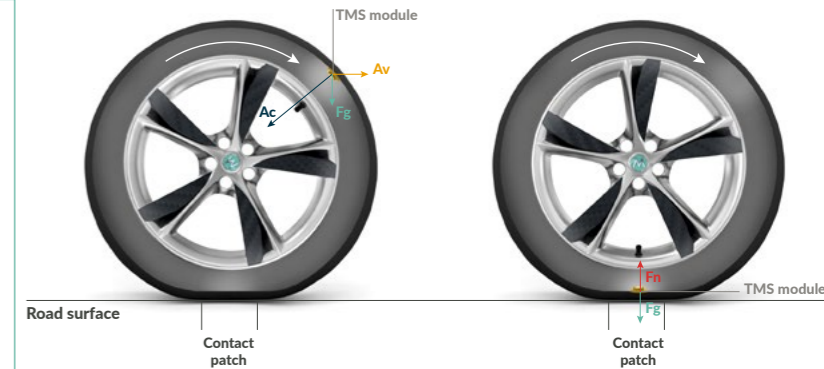

MAP PRESSURE SENSOR - In fuel-injected automotive engines, a manifold absolute pressure (MAP) sensor provides instantaneous manifold pressure information to the engine's electronic control unit (ECU).



PCB-less solution

8 TEMPERATURE SENSOR ICs

Melexis' contactless far infrared (FIR) temperature sensors can be used for in-cabin monitoring. Radiant temperature can be detected via single or multiple pixels. Our FIR arrays offer a detailed thermal picture and enable occupancy detection. Accurate high temperature control of the powertrain is enabled by our thermocouple interface ICs.

- Single pixel FIR
- FIR Arrays (32x24-16x12)
- Thermocouple interfaces
 - Dual & quad interface
 - SENT and PWM output

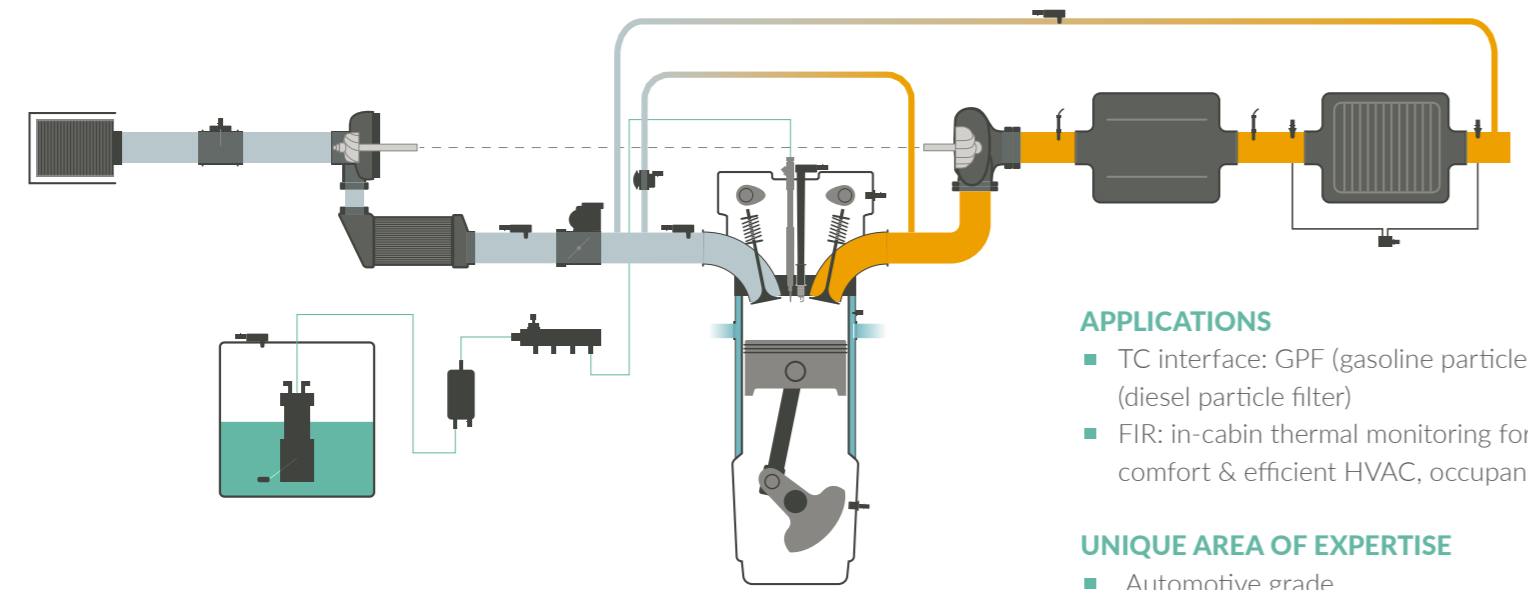
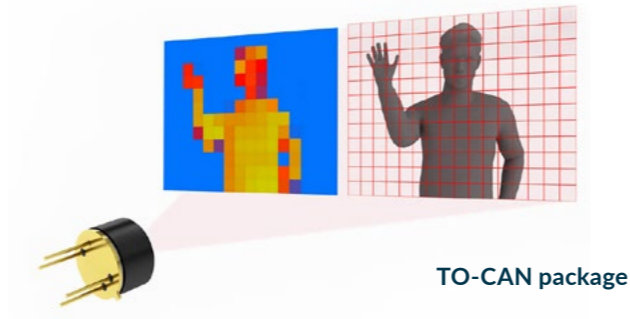

- APPLICATIONS**
- TC interface: GPF (gasoline particle filter) & DPF (diesel particle filter)
 - FIR: in-cabin thermal monitoring for enhanced comfort & efficient HVAC, occupancy detection

- UNIQUE AREA OF EXPERTISE**
- Automotive grade
 - Calibration for best accuracy

9 EMBEDDED LIGHTING ICs

Our LIN-based RGB LED drivers enable sophisticated yet cost-effective ambient lighting for vehicles from entry-level to mid-range and luxury models. The MLX811xx family raises the performance bar and lowers the external component count, thanks to the very high EMC robustness achieved by using silicon-on-insulator (SOI) technology and the full system-on-chip integration. Additionally, new products are designed in accordance with ISO 26262 to ease system-level functional-safety certification.

ANIMATED LIGHT

Our newest chip family supports extended lighting functions, like smart animated interior lighting, to create added value for the driver and passengers. Animated light can be used besides the use for interior design also to show car status information, like charging discharging, blind spot, distance warning and others.

STATIC LIGHT

The MLX811xx family contains a complete LIN system, including transceiver and protocol handler for connecting RGB ambient modules to the vehicle's existing LIN network. Compliant with LIN2.x and SAE J2602 standards, and supporting auto-addressing, the on-chip system enables minimal module size and bill-of-materials (BOM) costs.

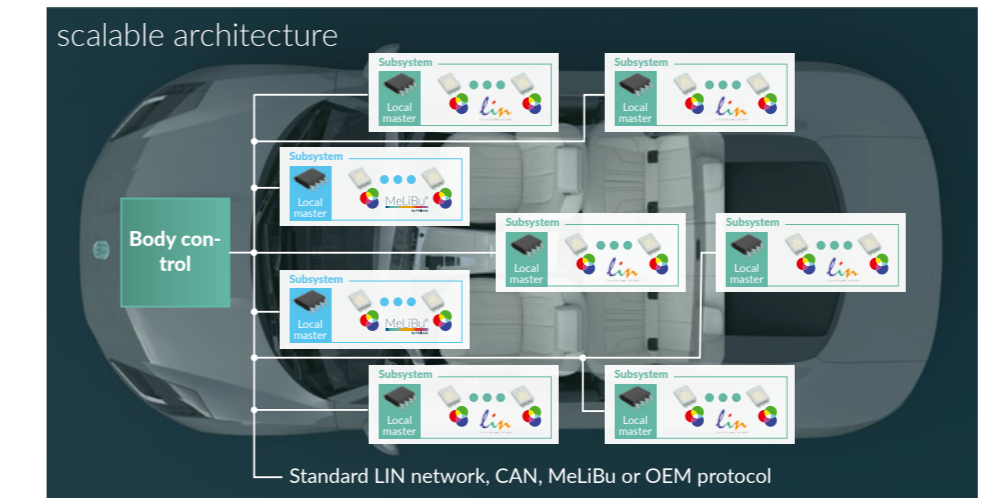

10 OPTICAL SENSOR ICs - TIME OF FLIGHT (ToF)

The industry is advancing towards greater levels of automation. Real-time monitoring of the driver's attention level, position, and movements is therefore crucial.

In-cabin monitoring and driver sensing

ToF technology is used for gesture recognition. The potential scope of ToF, however, goes way beyond this use case: ToF cameras are able to map a driver's hands position, head position and upper body position in 3D. This way it can be ascertained if the driver is facing the road ahead and if his/her hands are placed on the wheel.

ToF

ToF technology has gained a new momentum because of additional active safety standards (e.g. NCAP) and features required by level 4 and 5 autonomous vehicles, going beyond in-cabin use. ToF technology is now evaluated for exterior use cases like short range cocooning because it combines high resolution with accurate depth information at short range, complementing long range system such as camera and radar.

Evaluation kits for in-cabin monitoring

For initial testing, Melexis has complete ToF camera development kits for both QVGA and VGA resolutions, multiple field-of-views, with LED or VCSELs (Vertical-Cavity Surface-Emitting Laser) active lighting and different wavelengths (850 nm, 940 nm). Melexis application engineers support your in-house developments and manage cooperation with worldwide partners for customized software and hardware development and production.

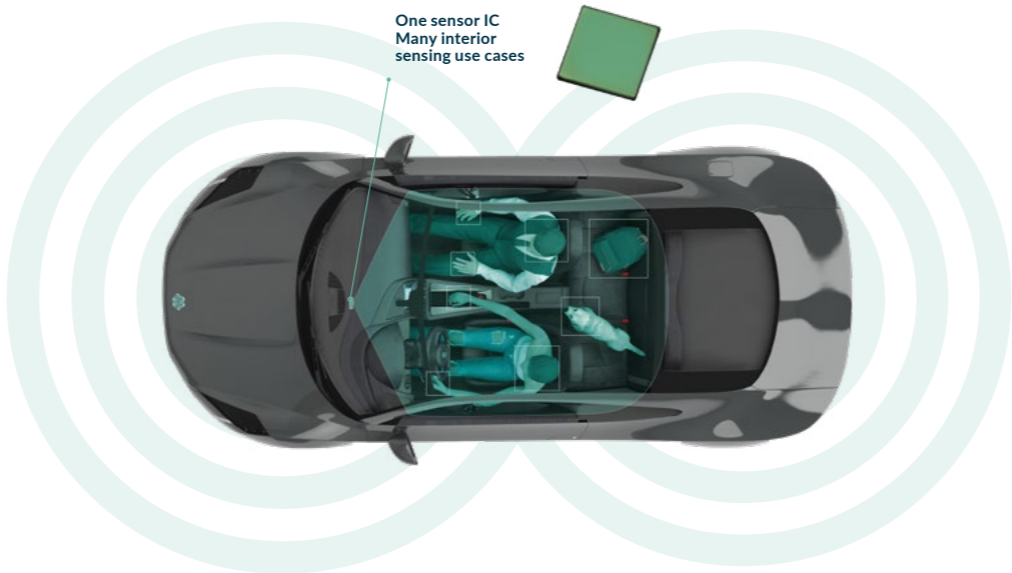
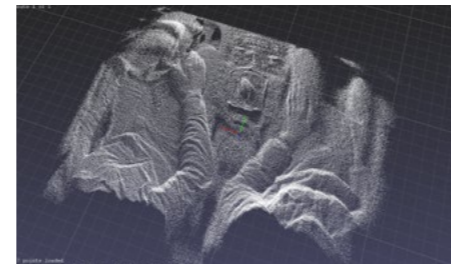

OPTICAL SENSOR ICs - TIME OF FLIGHT (ToF)

MELEXIS IC SOLUTIONS IN YOUR APPLICATION

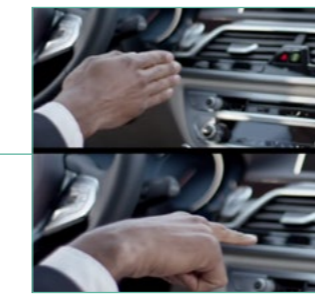

- Hand position interaction (intuitive HMI) with**
- Car displays
 - Cockpit functions like unroof and airco
 - Exterior environment

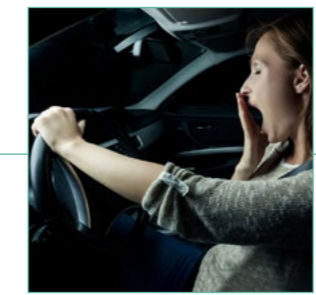

- Driver sensing for NCAP and L3, L4 autonomous drive handover**
- Body pose
 - Hands-on-wheel
 - Head pose
 - Eyes open-close
 - Eye gaze
 - Fatigue
 - Cognitive load
 - Hand position to detect smartphone use, drinks, etc.



- Personalization with body, head and face monitoring**
- Driver and passenger monitoring (DMS & CMS)
 - Body monitoring for seat and mirror adjustment
 - Head and face monitoring for people identification



- Active safety systems for NCAP and legal requirements**
- Driver, passenger, child classification
 - Smart airbag deployment
 - Seatbelt detection



- Autonomous vehicles**
- Blind spot detection
 - Collision avoidance
 - Autonomous parking
 - Smart access
 - Vehicle cocoon

Electric vehicle, (plug-in) hybrid
or combustion engine?

Melexis

Powertrain systems

Stringent legislative policies are in place to curb harmful emissions, so that future generations will be able to enjoy cleaner air. At the same time we are reducing our dependency on the planet's dwindling oil reserves. These dynamics show a migration towards hybrid and electric vehicles (HEV/ EVs). Melexis' products can be applied in both cars with a combustion engine as in electric vehicles..

ELECTRIC VEHICLE (EV)

- Thermal management
- High-Voltage inverter(s)
- Battery monitoring
- DC/DC converters
- On-Board Charger (OBC)

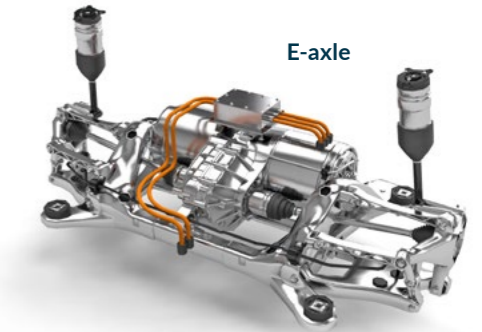
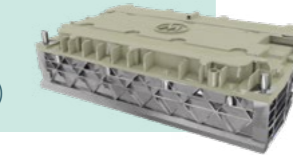

HYBRID ELECTRIC VEHICLE

- Down-sized engine (GDI, Turbo)
- Thermal management
- 48 V starter-generator unit
- Battery monitoring
- DC/DC converter (48-to-12 V)
- High-Voltage inverter
- E-turbo

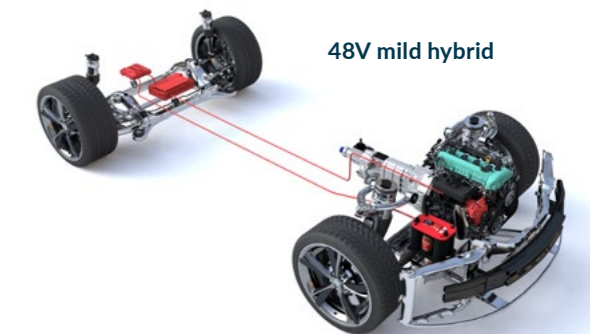
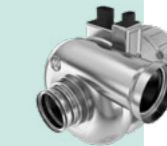

INTERNAL COMBUSTION ENGINE (ICE)

- Down-sized engine (GDI, Turbo)
- Thermal management
- Start-stop unit

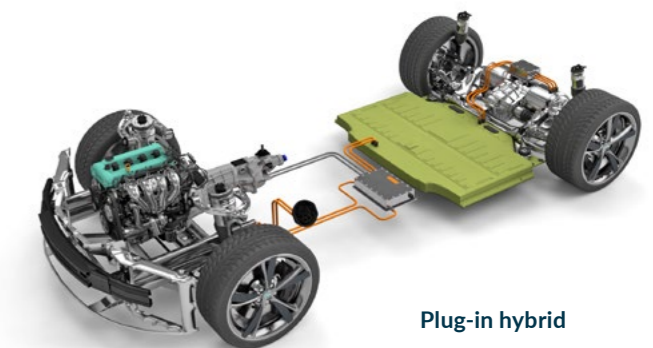

MELEXIS

ADDRESSING AUTOMOTIVE TRENDS

Next to the powertrain, our engineers focus mainly on innovations for the chassis, body and safety systems. Developing advanced integrated applications and solutions for these areas, driven by automotive trends such as personalization, advanced driver assistance systems (ADAS) and electrification, is our core business.



Melexis engineers small, smart sensing and driving nodes supporting in-vehicle edge computing systems.



BODY

- Lighting
- HVAC
- Seating, windows, roof
- Power tailgate
- In-cabin ToF monitoring

CHASSIS

- Steering torque
- Steering angle
- Braking
- Suspension
- TPMS

SAFETY

- Seat belts
- Seat position
- Adaptive headlights
- Rain sensors
- Driver monitoring

INSPIRED ENGINEERING

SENSE & DRIVE

- 1
Magnetic position sensor ICs
P 30
Effective, accurate and reliable position sensing
- 2
Current sensor ICs
P 32
Ideal for innovative applications in the fast-growing market for the electrification
- 3
Latch & switch ICs
P 34
Latch and switch devices detect the proximity of a magnet
- 4
Smart driver ICs
P 36
Cost optimized smart drivers for fans & pumps solutions
- 5
Inductive position sensor ICs
P 36
Effective, accurate and reliable position sensing



CUSTOMER-DRIVEN INNOVATION

WE ENABLE EDGE SENSING AND EDGE DRIVING

As a fabless semiconductor company, we engineer smart sensing and driving nodes that are used in a variety of applications. Our ICs communicate with the outside world and combine analog and digital signals.



SENSE & LIGHT

- 6
Pressure sensor ICs
P 38
Plug-and-play solutions for pressure sensing
- 7
Temperature sensor ICs
P 40
Contactless FIR temperature sensing (single pixel and array)
- 8
Optical sensor ICs
P 42
Time of flight, light and rain light sensors

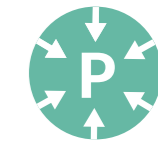

1 MAGNETIC POSITION SENSOR ICs

Effective, accurate and reliable position sensing is essential to many modern appliances. Our Triaxis® technology, based on magnetic contactless sensing, allows engineers to solve design challenges in domestic and industrial applications.

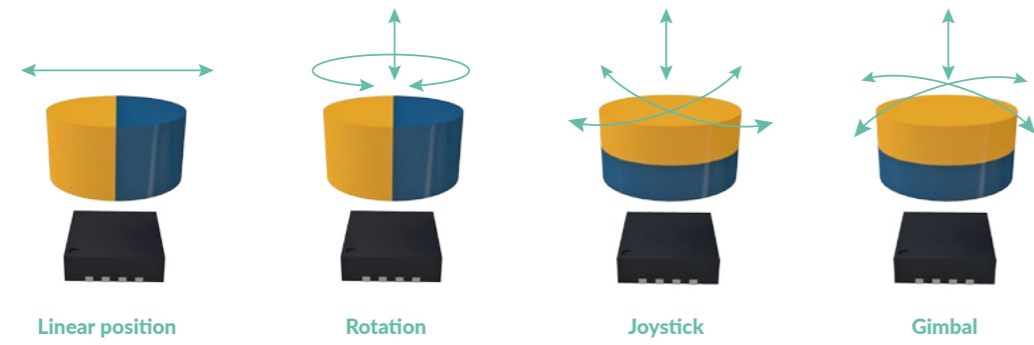

Triaxis® technology

Triaxis® is an innovative magnetic sensor technology capable of very precise three-axis magnetic field measurements (Bx, By and Bz) from a single sensor IC. The sensors can detect rotary, linear or joystick-type motion. The technology enable the use of smaller and lower-cost magnets. This makes our sensors perfect for elegant solutions in space and cost constrained automotive applications.



- Output: I2C, SPI, analog
- Magnetometer and position sensor
- Micropower options
 - low power down current
 - low supply voltage from 1.7 V
- Tiny surface mount and PCB-less packages suitable for space constraint applications
- Robustness (EMC, EOS)
- High accuracy:
 - Low thermal drift
 - Low noise

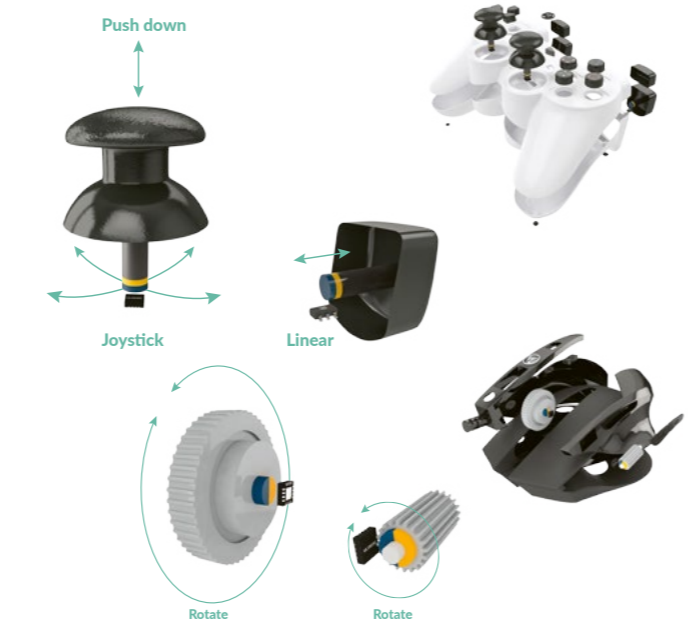

1+ BILLION SENSOR ICs SHIPPED
 Triaxis® has grown into a complete family of products covering the needs of position sensing applications in automotive and industrial products. This is an achievement we are very proud of.

MAGNETIC POSITION SENSOR ICs MELEXIS IC SOLUTIONS IN YOUR APPLICATION

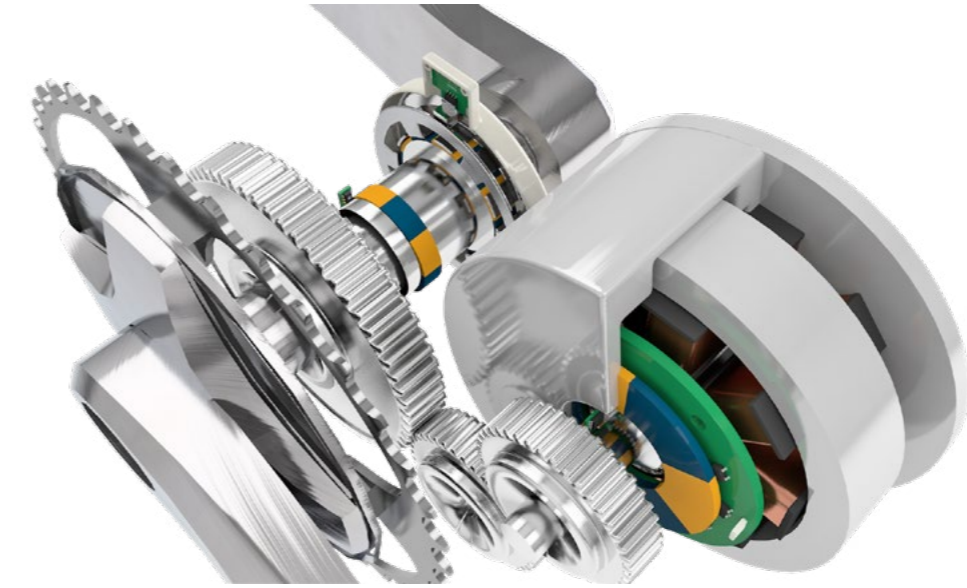

TORQUE SENSING
 Initiate pedal assist at the right time

MOTOR COMMUTATION
 Perfectly synchronizes your e-motors.

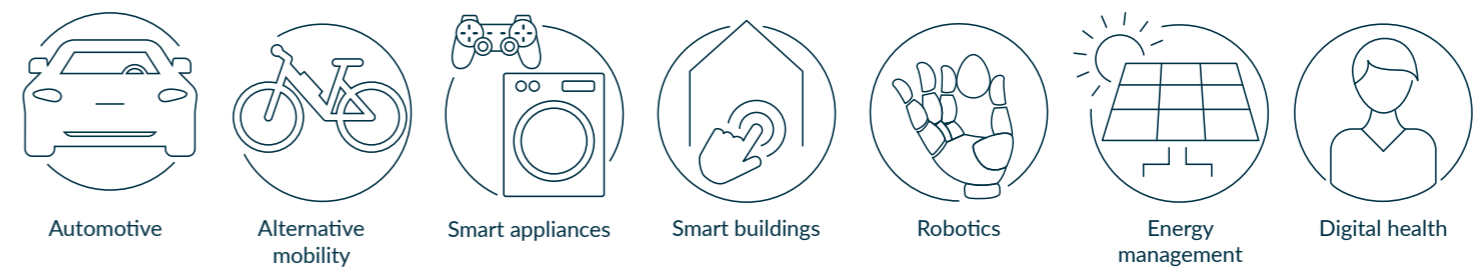
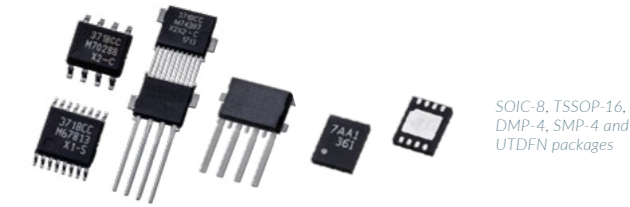

2 CURRENT SENSOR ICs

Our Hall-effect current sensors offer significant performance enhancements and a rugged design. It makes them ideal for the innovative applications found in various markets such as energy management, smart buildings, appliances and robotics.

The IMC-Hall® technology,

has found its way into battery monitoring applications. In recent years its deployment as a primary sensor in inverter and converter applications has been massive. The IMC-Hall® technology is now the preferred solution for many designers as it provides denser power electronics and a more flexible and lighter integration of the mechanical components with system cost reductions altogether.

The Conventional Hall technology,

has been around for decades and remains a solution for current sensing. It consists of a sensor IC combined with a ferromagnetic concentrator. This concentrator increases the flux density seen by the sensor and also provides attenuation of the possible external magnetic field influences.

Integrated solution,

are Hall-effect sensors with integrated current conductor and built-in stray field immunity for currents up to 50-100 A. The sensors ensure voltage isolation. They are qualified for use in a range of automotive and industrial applications, such as on-board chargers (OBC), DC/DC converters, power supplies, and small electric drives.

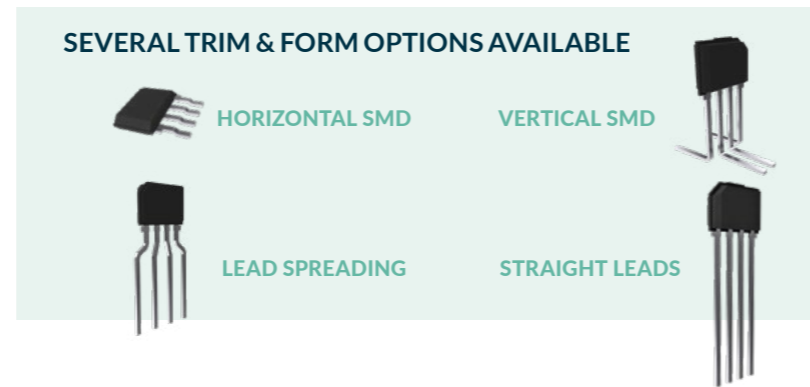
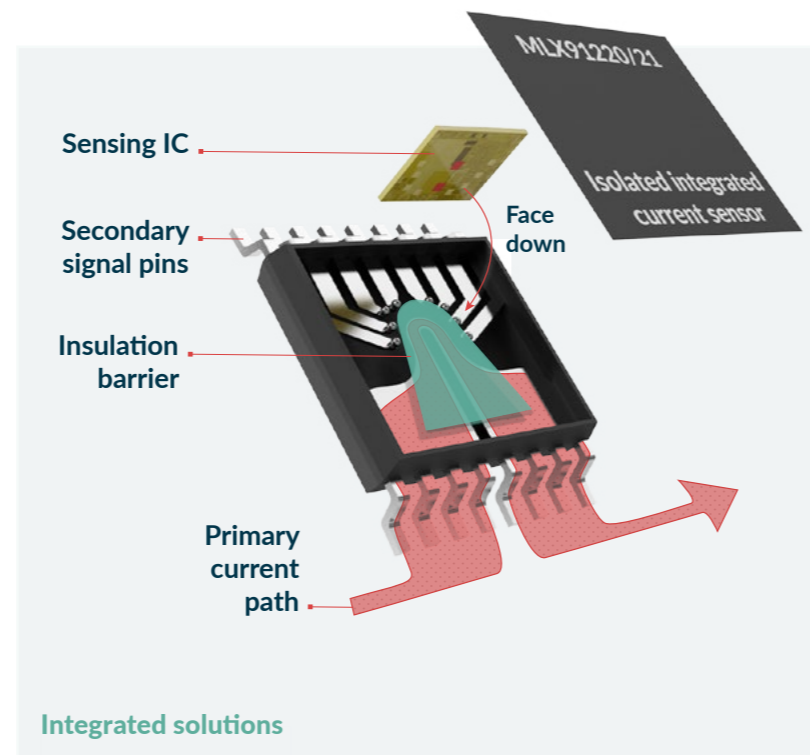
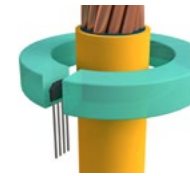
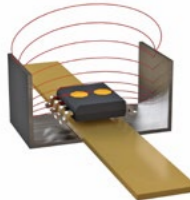

CURRENT SENSOR ICs

MELEXIS IC SOLUTIONS IN YOUR APPLICATION



AC & DC CHARGERS

Safely charge your electric devices

DCDC CONVERTERS

Simply convert the battery supply to the right voltages for your application.

SOLAR PANEL

Efficiently harvest solar energy

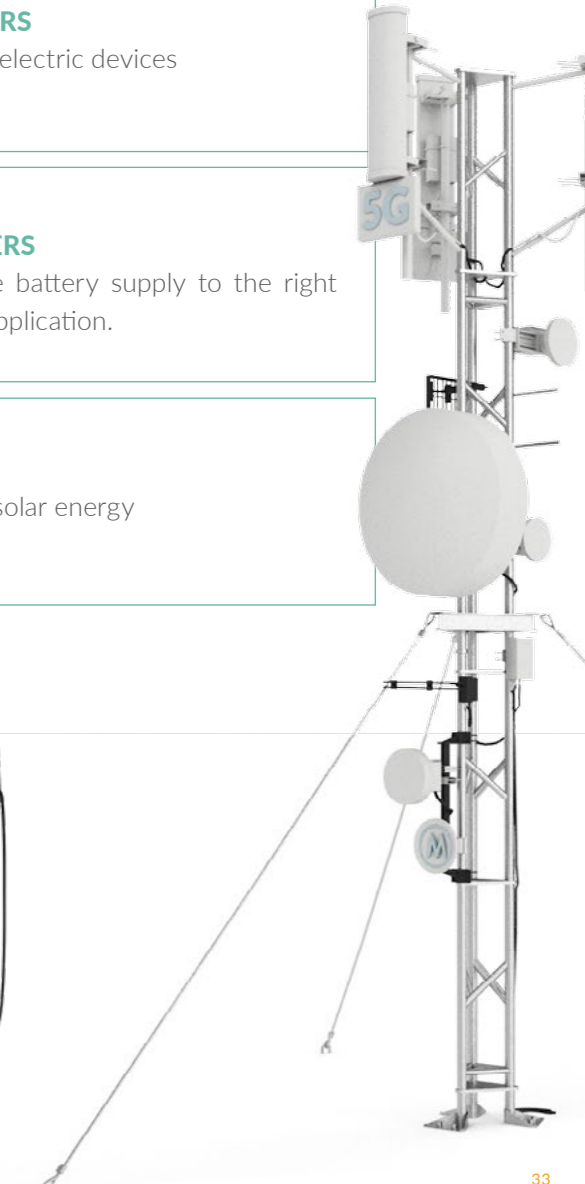

3 LATCH & SWITCH ICs



Magnetic latch and switch devices rely on the principles of the Hall-effect to, through the position of a magnet, determine the physical position of an object. These on-off switching devices are very common in all markets as they enable basic automations.

Compact module designs

Melexis' Latch & Switch sensors use an innovative magnetic technology that allows the measurement of the lateral magnetic flux component. Thanks to their integrated magnetic concentrator (IMC), they allow the magnet to be placed beside the sensor, thereby saving space and enabling new applications where previously there was not enough room for a magnetic sensing solution.

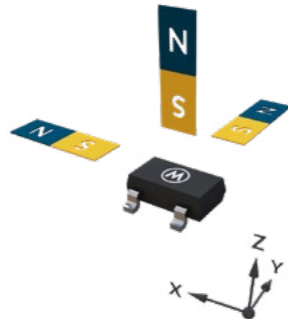

Back-biased applications speed sensing with a simple switch

As a result of the inclusion of IMC technology, simple wheel speed sensing on motorcycles for example can now be performed using a single two-wire switch sensor with integrated capacitor (MLX92242 or MLX92241) and a traditional magnet. This approach uses the lateral field instead of the perpendicular field, thus vastly simplifying the designer's task.

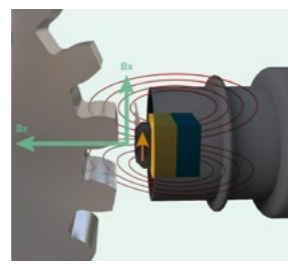

- 2-, 3- and 4-wire latch and/or switches
- Single and dual die
- Micro-power
- Pre-programmed and programmable (EEPROM)
- IMC for lateral sensing solution
- PCB-less option with integrated cap in UA-package

3 Melexis **BILLION** SWITCHES SHIPPED

3+ BILLION SENSOR ICs SHIPPED
 In 2022, the 3 billionth Melexis Latch & Switch sensor IC has been shipped. This milestone wouldn't have been reached without our internal dedicated teams, our broad partner base, operational activities in development, worldwide footprint, and last but definitely not least, our customers who pushed us to where we are today.

LATCH & SWITCH ICs MELEXIS IC SOLUTIONS IN YOUR APPLICATION

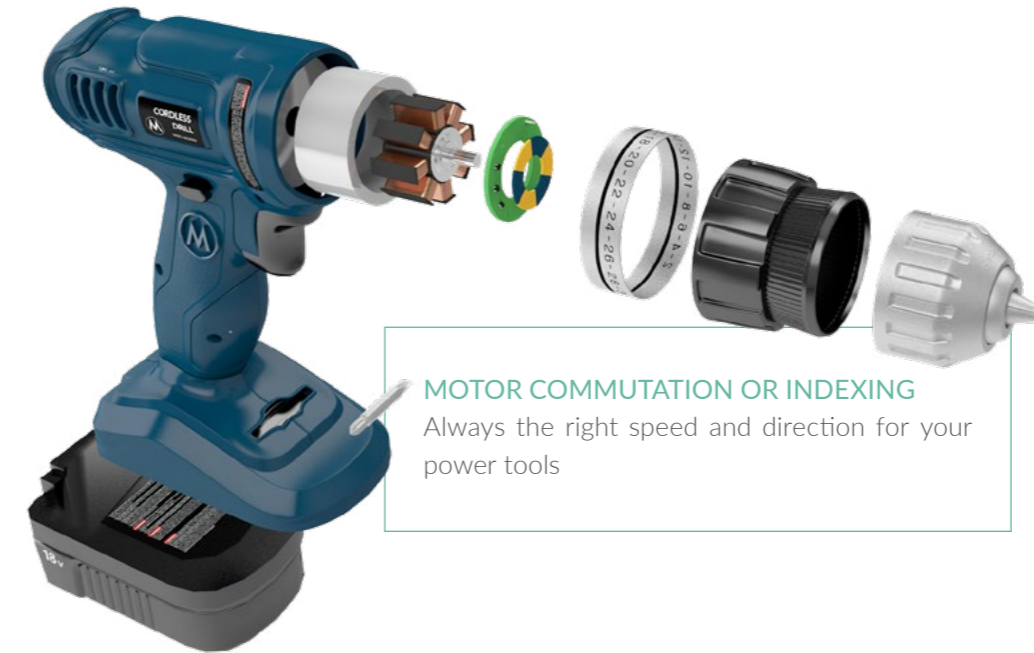

MOTOR COMMUTATION OR INDEXING
 Always the right speed and direction for your power tools



FLOAT LEVEL
 Easy way to measure liquid levels



PTC-04
 The PTC-04 programmer is designed for efficient and precise calibration of Melexis ICs. It can be easily adapted to a standard PC and to an application module to allow calibration of programmable sensor ICs within the operating environment.

The PTC-04 contains its own programmable power supply, measurement circuitry, dedicated features (such as 16-bit voltage and current measurement capability) and a configuration option that will accommodate users from the prototyping phase directly into production. IC based hardware and a PC are required to load software to the programmer and control the functions of the programmer. Consult us for more information.

4 INDUCTIVE POSITION SENSOR ICs

Inductive position sensors are used in applications that require very high position sensing accuracy under the harshest condition of magnetic stray fields and temperature.

ABSOLUTE ROTARY POSITION SENSING

- Resolver with differential sine and cosine outputs
- Through-shaft, end-of-shaft and side-of-shaft operation

UNIQUE AREAS OF EXPERTISE

- Stray field immunity
- High accuracy
- Low thermal drift
- High temperature operation
- EMC robustness (transient, immunity, emission)
- Application support including coil design

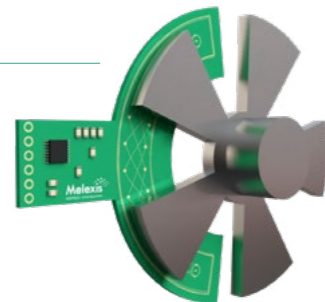

5 SMART DRIVER ICs

Enabling cost-optimized, minimum-size and whisper-silent cooling solutions for automotive and consumer applications.

BROAD PORTFOLIO

- From 0.1 W to 40 W
- From 5 V to 32 V
- 1-coil
- Fans and pumps

UNIQUE AREAS OF EXPERTISE

- Optimized for low acoustic noise operation, and/or maximum torque
- Plug-and-play, no software development
- High quality at low cost
- High robustness against EOS (Electrical Over Stress)
- Extensive protections (LRP, OV, UV, OC, OT)
- packages with very small footprint

FANS/PUMPS

- CPU/GPU cooling
- Air quality sensor
- Battery cooling
- Cell phone wireless charger



SMART DRIVER ICs MELEXIS IC SOLUTIONS IN YOUR APPLICATION

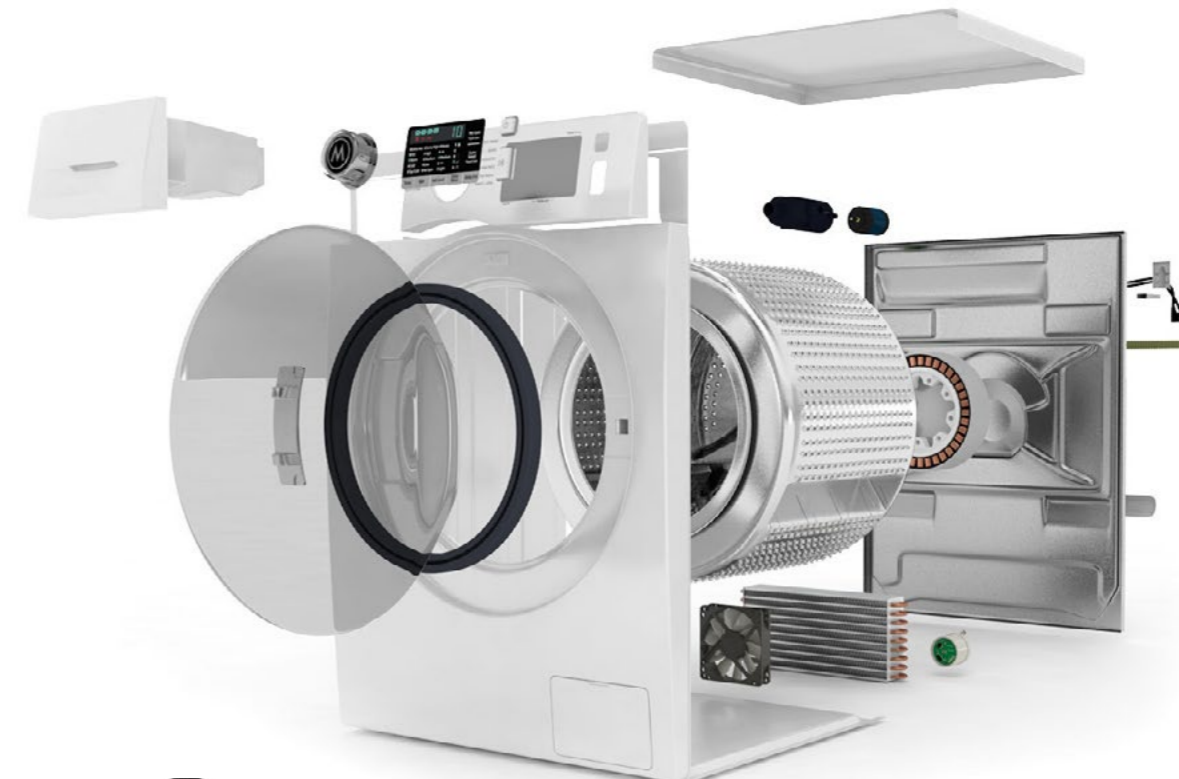

DRAIN PUMPS

smart and cost effective drainage for your washing machines

COOLING FANS

Avoid damage by efficient cooling



E-scooter



Robot vacuum



Robot mower

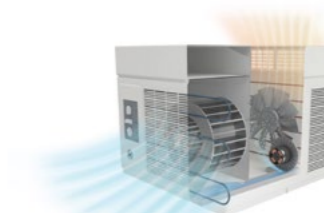

Swamp cooler

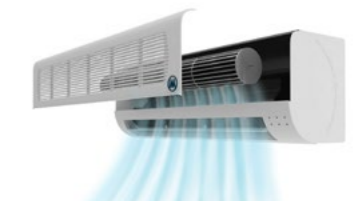

Air conditioner

6 PRESSURE SENSOR ICs

The royalty of MEMS. We are unique and leading partner as all pressure sensor segments can be addressed by our advanced technologies. MEMS, signal conditioning, factory calibration, packaged or not, PCB-less... Absolute or relative measurement from low to high pressure applications. When you are looking for plug-and-play solutions with the best-in-class robustness and performances in demanding harsh environments you've found your partner of choice.



MLX90809 MLX90818
KINGDOM OF MEMS

LOW 0.1 - 5 bar
Lawn mower, chain saw and other small engines.

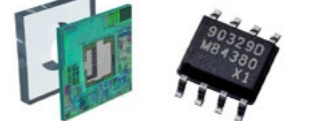

MLX90819 MLX90329
MEMS VS. CERAMIC

MID 5 - 70 bar
HVAC, transmission/engine oil, etc.



MLX90329
INTERFACES

HIGH 70+ bar
Common rail, turbine, etc.

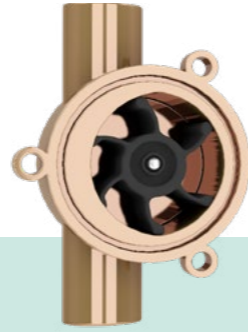

Our pressure sensors can successfully be integrated in active pumps together with Melexis motor drivers and magnetic position sensors.



PCB-LESS SOLUTION
The design of the package includes ridges to enable glued pressure seals. It makes it easy to integrate. The smart package and die assembly concept enable high output stability over life-time, even in stringent temperature and stress conditions.
Discover the complete family of PCB-less ICs, for both absolute and relative pressure sensing.

PRESSURE SENSOR ICs MELEXIS IC SOLUTIONS IN YOUR APPLICATION

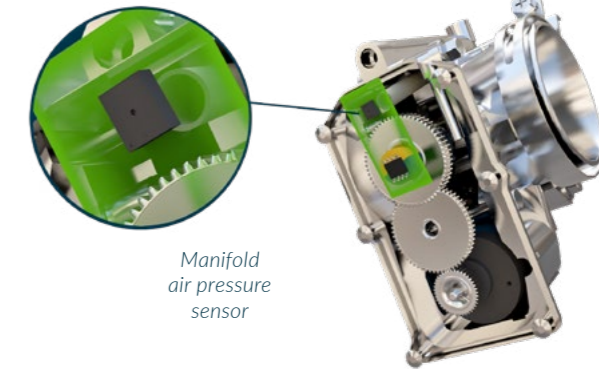

Manifold air pressure sensor

MAP PRESSURE SENSOR

In fuel-injected engines, a manifold absolute pressure sensor provides instantaneous manifold pressure info to the engine's electronic control unit (ECU).

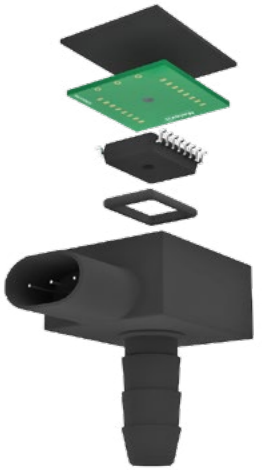

Lawn mower



Chainsaw



Boat motor

7 TEMPERATURE SENSOR ICs

Melexis' contactless far infrared (FIR) temperature sensors enable new ways of temperature monitoring, be it with single or multiple pixel system. Melexis surface mount capabilities (QFN) also support innovation in a whole new world of wearables. Discover the true advantages of contactless temperature sensing.



TEMPERATURE SENSOR ICs MELEXIS IC SOLUTIONS IN YOUR APPLICATION



CONTACTLESS TEMPERATURE SENSING:
ACCURATE AND REPEATABLE

HEALTH STATION

8 OPTICAL SENSOR ICs - TIME OF FLIGHT (ToF)

The industry is advancing towards greater levels of automation in the coming years, but even with greater levels of automation, the driver will still need to be able to take control in certain circumstances. Real-time monitoring of the driver's attention level, position and movements is therefore crucial.

Time-of-flight for your 3D Sensing Applications

This sensing technology is able to detect people and objects, their absolute position, movement and shape in 3D. Optical ToF systems use infrared active illumination. This illumination source - an LED or VCSEL (Vertical-Cavity Surface-Emitting Laser) - illuminates a scene through beam-shaping optics. Once this light has reflected off the scene, a ToF camera records the reflected light and measures the elapsed time or phase-shift from the reference. The distance is then calculated based on the total flight time of the light (at the speed of light!), Hence the term "time-of-flight".



Evaluation kits

For initial testing, Melexis has complete ToF camera development kits for both QVGA and VGA resolutions, multiple field-of-views, with LED or VCSELs active lighting and different wavelengths (850 nm, 940 nm). Melexis application engineers support your in-house developments and manage cooperation with worldwide partners for customized software and hardware development and production.



OPTICAL SENSOR ICs - TIME OF FLIGHT (ToF)

MELEXIS IC SOLUTIONS IN YOUR APPLICATION



Retail

- People counting
- Shelf analysis
- Inventory monitoring



Robotics

- Collaborative robots
- Safety perimeter
- Human machine collaboration
- Behavior prediction
- Workpiece identification



Smart cities

- Smart street lighting
- Free parking slots
- Access control
- People counting



Logistics

- Object identification and tracking
- Sizing and damage control



Autonomous transport

- AGVs
- Path planning/SLAM
- Precision approach and docking
- Obstacle detection and collision avoidance



Melexis



Melexis

INSPIRED ENGINEERING

RECOGNITION

- **2021 GASGOO award**
- **2020 "Excellent performance: MLX90632"** by CHINA IOT AWARD
- **2019 "Best of Sensors"** award for medical-grade temperature sensor MLX90632
- **2019 "Industry leader in diversity and inclusion award"** by ISS Europe
- **2019 "Value Creation award"**: one of the three Belgian listed companies who created the most value in the past 10 years
- **2019 and 2017 "Excellence in Product Design for Automotive"** for TPMS and "Product Design for Medical" for MLX90632 at the awards
- **2018 BNP Paribas global prize** for women entrepreneurs
- **2018 and 2015 "Most Attractive Employer"** regional award by Randstad
- **2017 "Best Semiconductor Employer Award in China"** by Moore Elite for: Best Place to Work, Best Corporate Social Responsibility, Best Employee Development and Fairest Compensation & Benefits
- **2016 Customer Sonceboz (CH) Innovation Award**
- **2016 Vlerick award 'Legacy & Promise'**
- **2016 Forbes**: 1 of the most trustworthy companies in Western Europe

30 YEARS OF INSPIRED ENGINEERING

For over 30 years, Melexis has been imagining - and creating - the best imaginable future. Throughout this journey, we never stop focusing on providing innovative solutions that enhance the daily comfort and safety of our customers' end-users.

We serve many markets....

Melexis operates mainly in the semiconductor market for cars, a market that has a solid foundation and exciting growth opportunities. However, we continuously build on our knowledge and experience and are expanding our scope to include new applications, new markets and new sectors, including 2-wheelers, home and consumer electronics, industrial applications and healthcare.

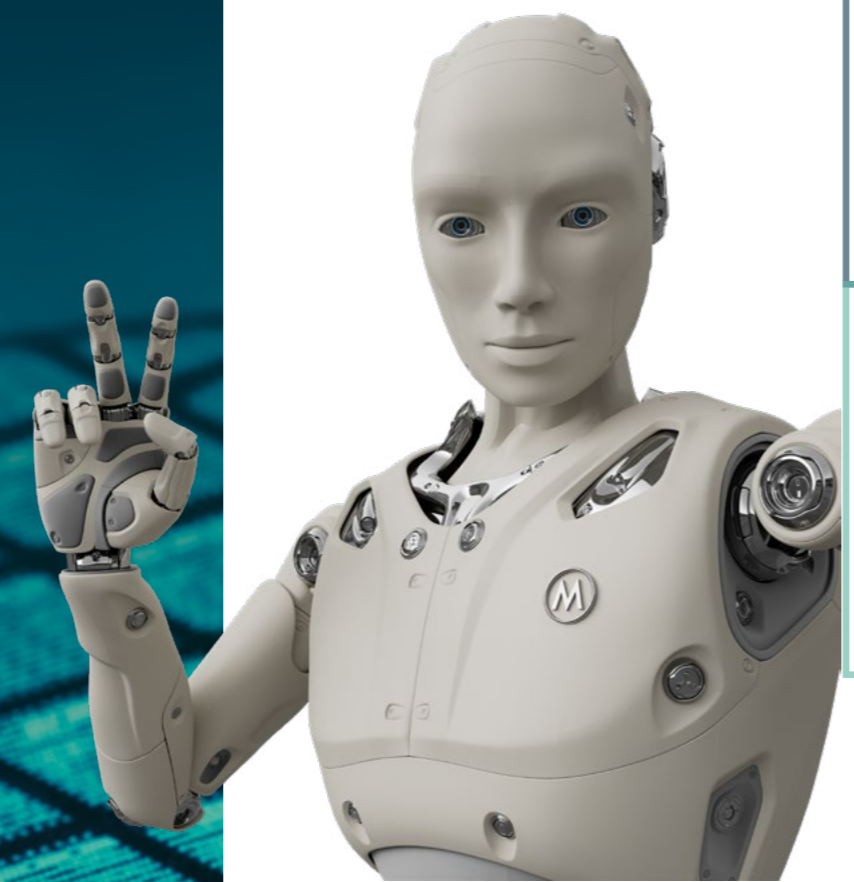

For more information, visit
www.melexis.com



Melexis

CONTACT MELEXIS:

EUROPE, MIDDLE EAST AND AFRICA
sales_europe@melexis.com

ASIA AND OCEANIA
sales_asia@melexis.com

AMERICAS
sales_usa@melexis.com

WWW.MELEXIS.COM

V2/02.2023

