



APPLICATION NOTE

Guidelines for overmolding of plastic encapsulated ICs

Revision 1.0 – September 2021

Advanced Customer Solutions

Guidelines for overmolding of plastic encapsulated ICs

1. Scope

2. Overmolding of PCB-less assembly

3. Overmolding of PCBA

1. Scope

Overmolding of Melexis products

Overmolding is a process by which a Melexis IC on a PCB or on a PCB-less assembly is inserted into an injection molding tool, and a molten polymer material is injected to surround partly or completely the assembly. In this way, the electronics can be embedded in a plastic housing, for environmental protection and mechanical robustness.

Both thermoset and thermoplastic material can be used with overmolding Melexis plastic encapsulated ICs. The material choice depends on module size, application environment (media) and customer experience and preference with overmolding process and material.

Storage and handling of Melexis devices at customer side should follow guidelines in J-STD-033 *Handling, Packing, Shipping and Use of Moisture/Reflow Sensitive Surface Mount Devices*. Key parameters are printed on the label attached to the product packing. Refer to *Guidelines for storage and handling of plastic encapsulated ICs* on Melexis website for details.

Guidelines for overmolding of plastic encapsulated ICs

1. Scope

2. Overmolding of PCB-less assembly

3. Overmolding of PCBA

2. Overmolding of PCB-less assembly

Family of Melexis packages for PCB-less applications

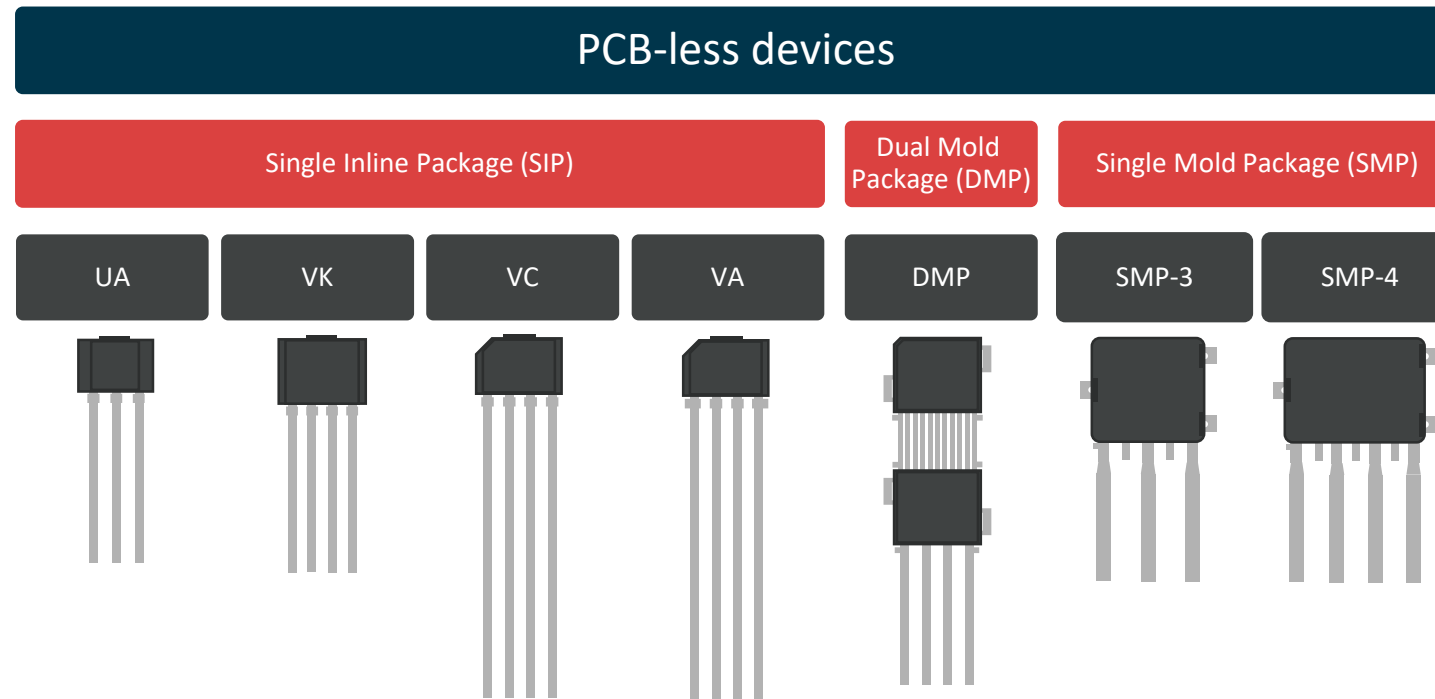

Refer to Annex I for the different abbreviations

2. Overmolding of PCB-less assembly

Basic overmolding flow for PCB-less applications



Overmolding usually consists on the following steps:

- 1. IC positioning onto leadframe or carrier:** The IC is directly positioned on the housing leadframe. It is also possible to pre-mold the connector, usually with a thermoset material. During subsequent overmolding the carrier replaces the bottom mold tool as a support surface
- 2. Welding:** Electrical connection of the pins to the housing leadframe is achieved during welding
- 3. Positioning of IC into tooling:** The IC (or IC and carrier) are positioning in a nest within the mold tool.
- 4. Closing of mold tool with clamping force:** Clamping force guarantees that the top and bottom mold tool keep closed.
- 5. Mold injection and cooling down/cure:** Thermoset or thermoplastic material is injected in the tooling mold cavity. Then the molten material is cooled down (thermoplastic) or cured (thermoset) to harden.
- 6. Singulation:** After removal from the mold tool, parts have to be singulated if a multi cavity tool is used or the parts have been overmolded on a leadframe strip.

2. Overmolding of PCB-less assembly

Mold tool design for XY positioning

XY positioning is achieved by the connector leadframe. It is not recommended to have XY positioning features within the mold tool to avoid conflict during positioning: this might lead to a torque force on the IC and deformation of the IC leadframe.

The support surface for the IC mold package should be planar: non-planarity shall not exceed 30um (over 5 mm). This is to prevent bending stress on the package during high temperature impact of overmolding. Enough clearance on needs to be foreseen to avoid spring loading of the leads versus the package due to thermal elongation during overmolding.

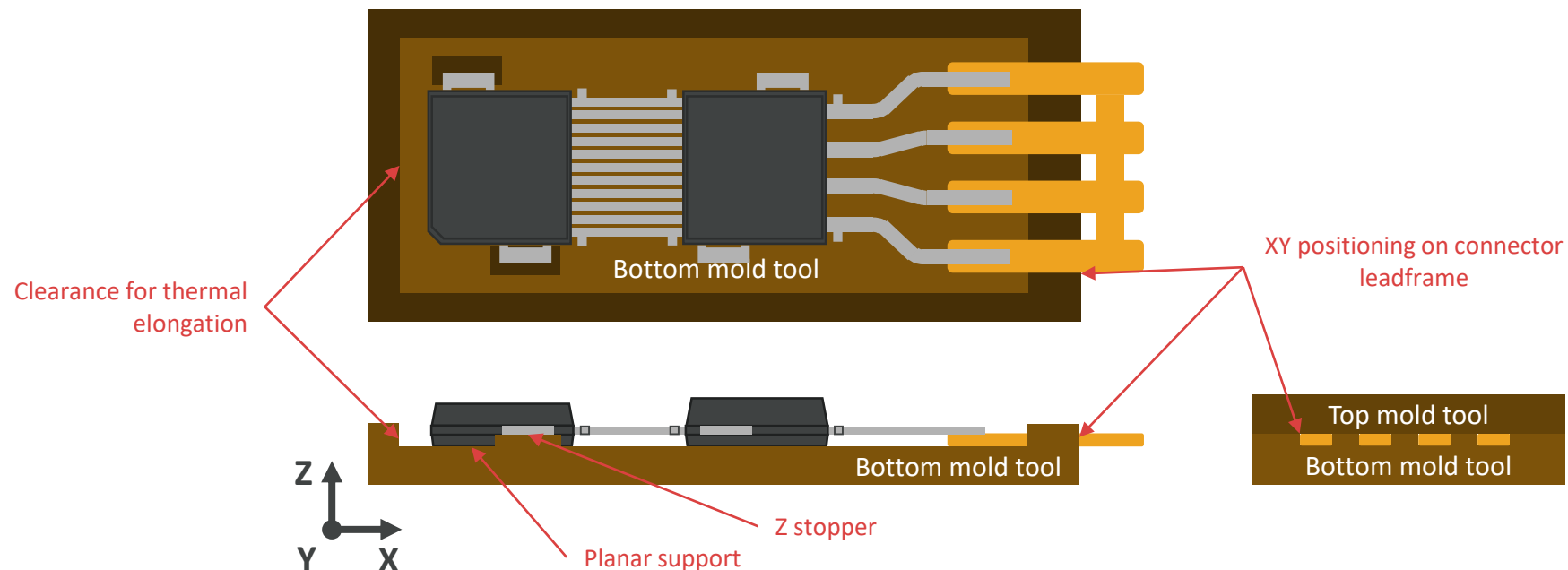

2. Overmolding of PCB-less assembly

Mold tool design for Z fixation on leadframe elements

Z fixation (clamping) on leadframe elements (ears) is allowed, but no visible tool mark should be left on them. Enough clearance shall be foreseen so that no deformation (pusher intrusion) of the leadframe elements is produced. If several clamping points exist, care should be taken to avoid non-planarity of the part.

A second option is creating a fork structure in the Z stopper (with enough XY clearance to avoid conflict with the leadframe) so the clamping force is applied only on the mold tool

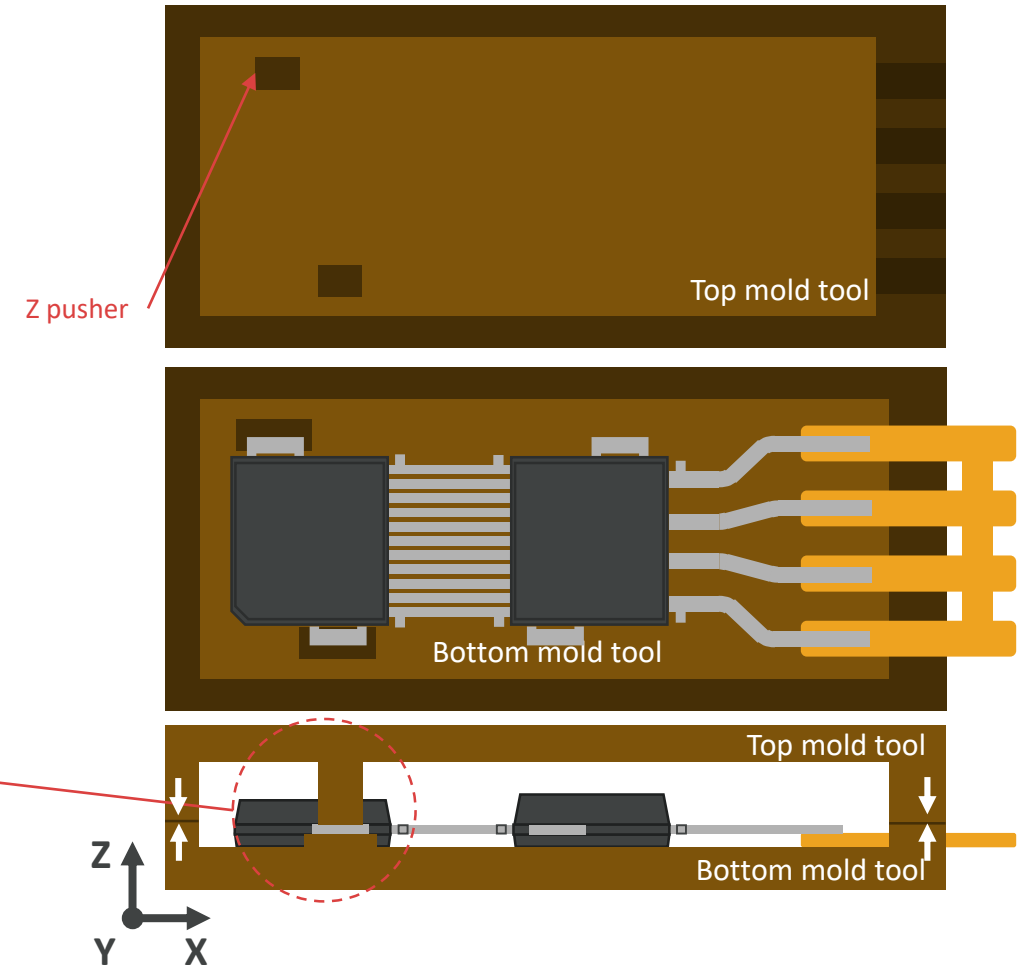
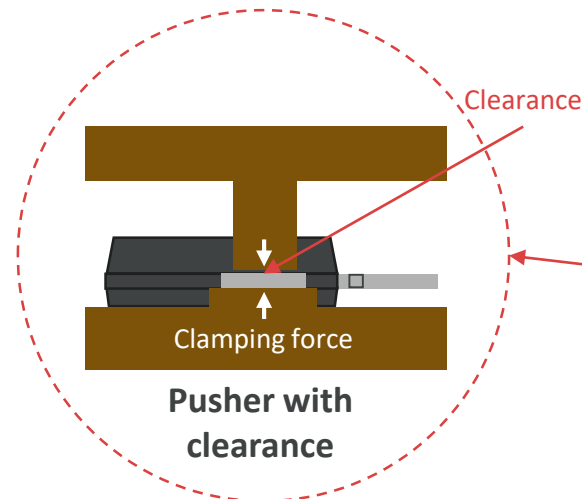

2. Overmolding of PCB-less assembly

Mold tool design for Z fixation on mold body

Z fixation (clamping) on the mold is allowed, but the maximum pressure shall not exceed 3N/mm^2 to avoid mechanical damage. Therefore enough clearance needs to be calculated so a reduced clamping force or no clamping force at all is applied on the mold.

A second option is using built-in spring loaded pusher, which clamps on the mold without applying all the clamping force from the tooling.

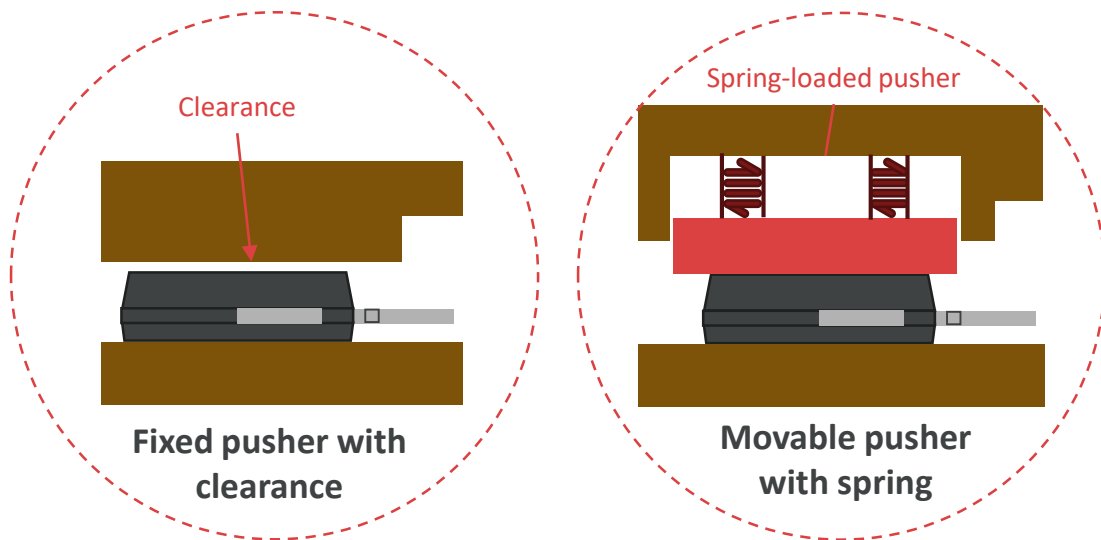
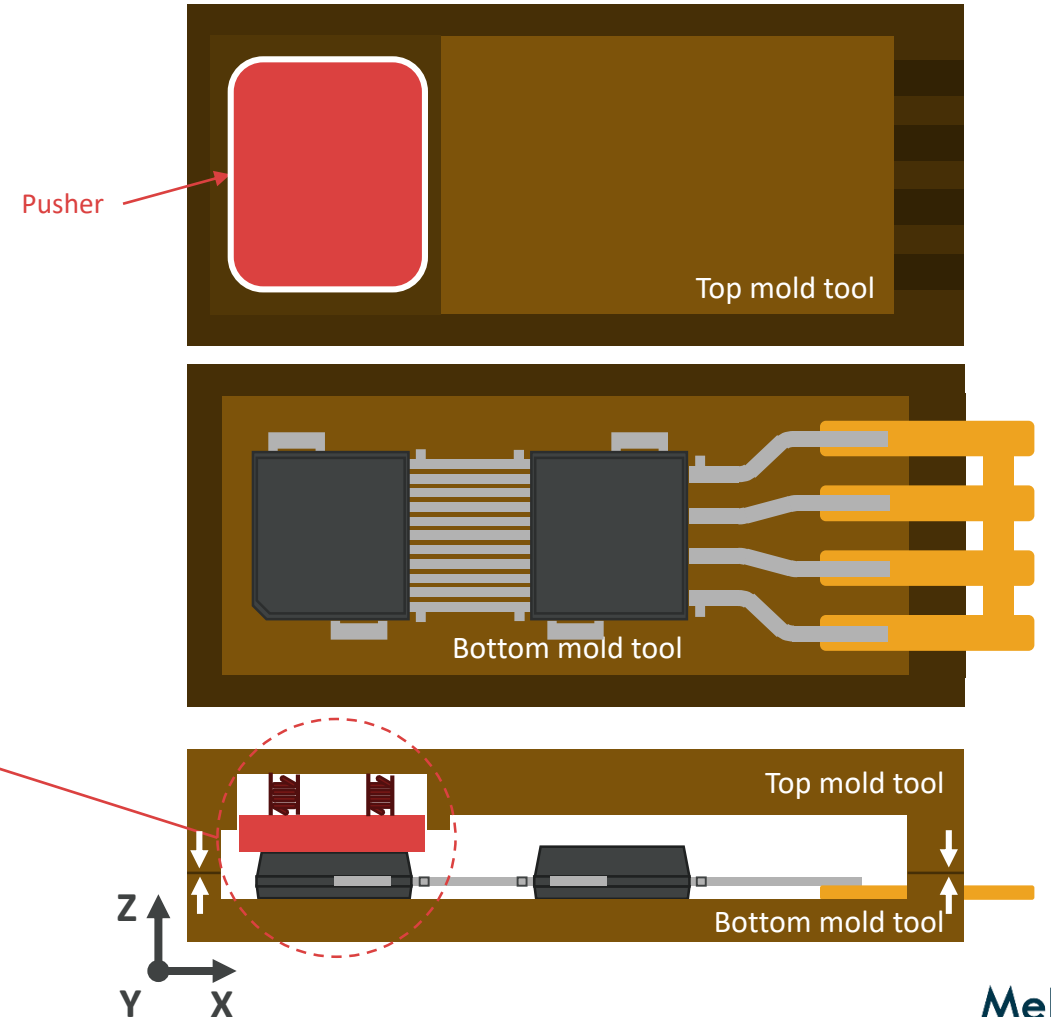

2. Overmolding of PCB-less assembly

Full overmolding

The injection gate should not be placed directly on the IC leads as it can cause tin (Sn) finish melting. It also should not be placed directly on the IC mold package active surface as it may cause thermal shock and temporary parameter drift. It is recommended to place the injection gate on the side of the connector terminals (which themselves serve as a heat sink).

Mold bleed on top of the IC mold body is allowed. This might happen if the mold tool is designed in such a way that the IC mold body is exposed to reduce distance to a target.

Retractable positioning pins might be used if exposed leadframe elements are undesirable.

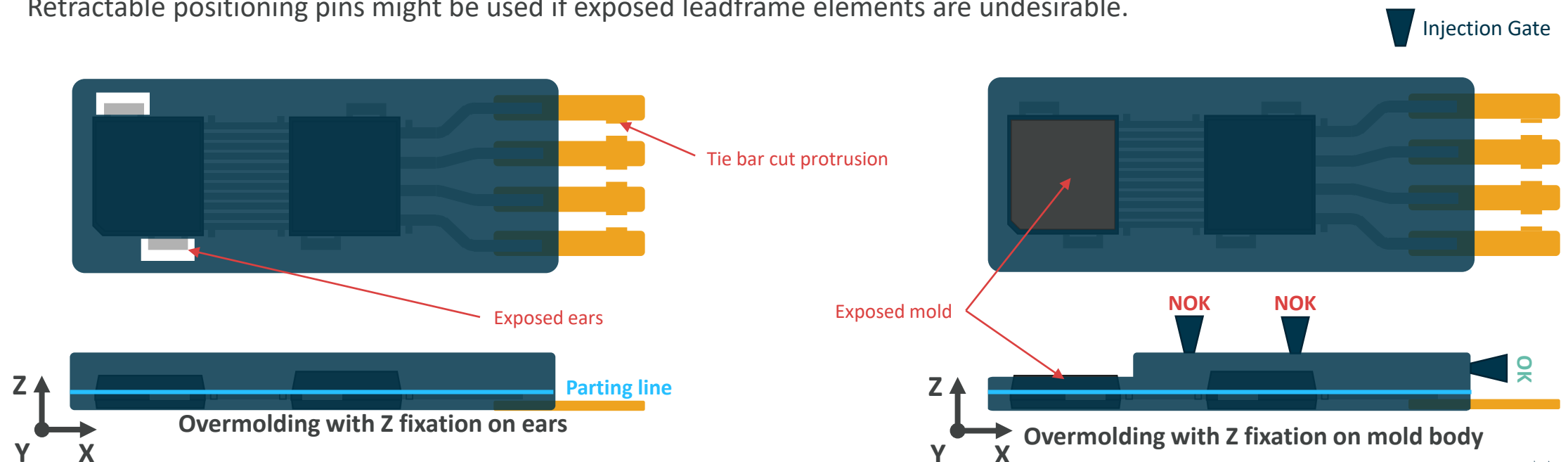

2. Overmolding of PCB-less assembly

Partial overmolding

Partial overmolding of the mold body is allowed. The parting line shall not cross the IC active area to avoid stress concentration on the silicon die, which might lead to die crack.

The same restriction for a clamping pressure on the plastic mold that does not exceed 3N/mm^2 applies.

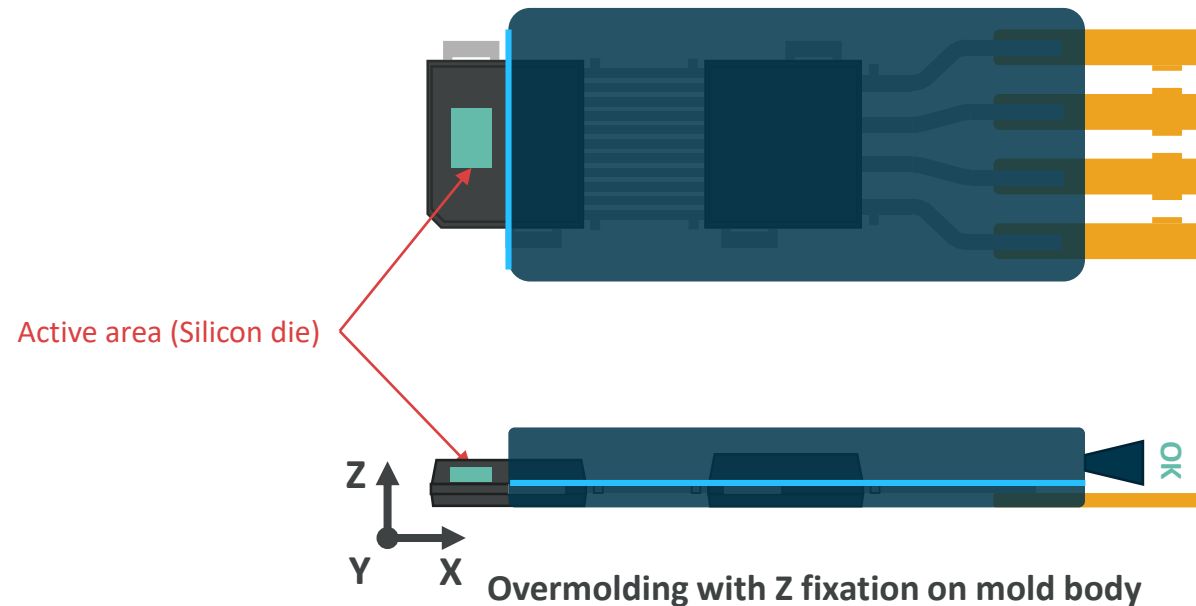

2. Overmolding with thermoplastic

Overmolding with **thermoplastic** materials

Thermoplastic overmolding can be applied. Customers applied thermoplastics as PA66GF30, PBT GF30, etc.

Overmolding tool and process design should target a maximum temperature on the IC mold package of 270C during the overmolding process. This temperature is a known value from Melexis adequate reliability stress test and proven by success in customer application. The risk of exceeding it is an internal package delamination of the mold-leadframe interface

Injection pressure value impact is not studied in depth. However pressure value of 400 bar had been applied successfully.

2. Overmolding of PCB-less assembly

Overmolding with **thermoset** materials

Thermoset overmolding is tricky to apply for a large size of mold cavity. The challenge is to maintain proper temperature profile during injection and flow inside the cavity and avoid early cure before the mold cavity is completely filled. Pressure sensors placed in each cavity of the mold can indicate if early cure takes place. The advantages of using thermoset overmolding are:

- Lower process temperature
- CTE (Coefficient of Thermal Expansion) close to Melexis IC mold compound.

Injection pressure for thermoset materials may go up to 210-230 bar and injection temperatures up to 175C. These values do not represent a risk for Melexis component performance or reliability.

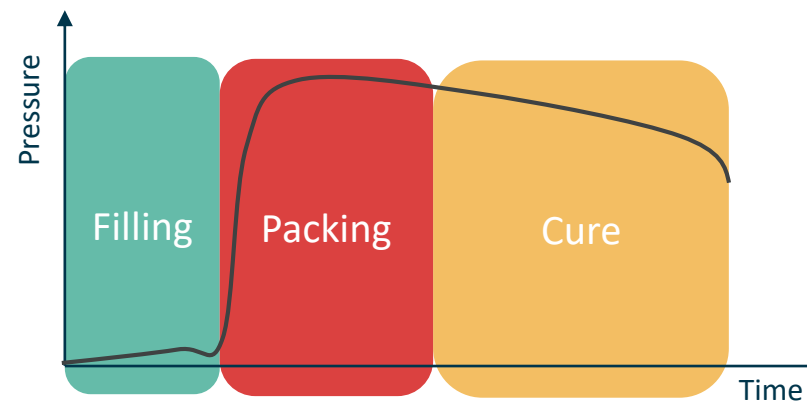

Overmolding pressure over time for a given temperature (thermoset)

2. Overmolding of PCB-less assembly

Known pitfall - Melting of tin plating during thermoplastic injection

Care should be taken to prevent melting of Sn lead finish during thermoplastic injection. It may happen if temperature stays above 232C (tin melting point) for more than few seconds. Melting of lead finish might create a conductive path between two leads that might behave as a short or as an intermittent contact in the application.

It is recommended to apply 100% X-ray inspection during process setup looking for the following defects:

- Tin melting, solder ball splattering and short between pins
- Residual stress on leadframe leading to bending, deformation or twisting of pins or the leadframe

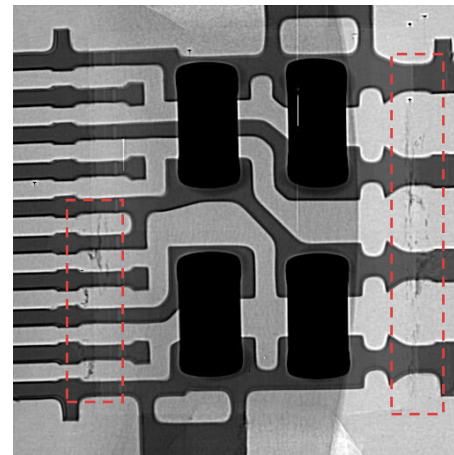

TOP VIEW

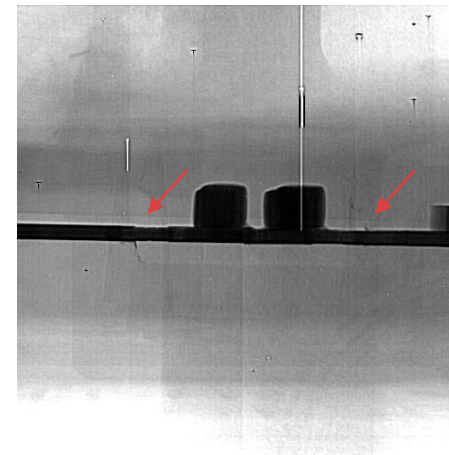

SIDE VIEW

Example of tin plating after overmolding on a DMP

Guidelines for overmolding of plastic encapsulated ICs

1. Scope

2. Overmolding of PCB-less assembly

3. Overmolding of PCBA

3. Overmolding of PCBA

Family of Melexis packages for PCBA applications

Surface Mount Devices (SMD)

Gull wing

Straight leads

Bottom Terminated Component (BTC)

SOIC

TSSOP

SSOP

SOT

QFP

SOIC

SOT

QFN

DFN

UTDFN

BGA

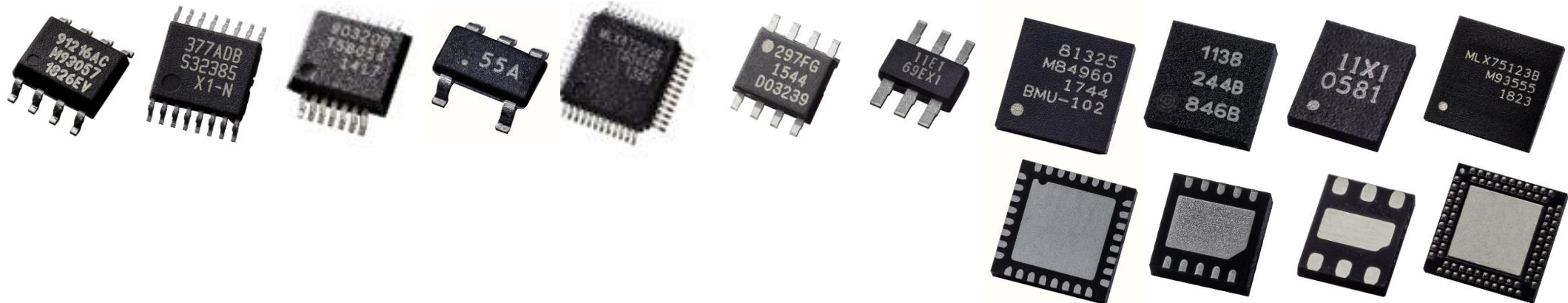

Refer to Annex I for the different abbreviations

Overmolding of cavity packages (optical or pressure sensors) is not allowed

3. Overmolding of PCBA

Basic overmolding flow for PCB applications



Overmolding usually consists on the following steps:

- 1. IC positioning onto PCB:** IC is extracted from tape and placed on the PCB on top of the solder paste with a PnP (Pick And Place) machine.
- 2. Soldering:** After sensor positioning on the PCB, the solder paste is melted through different methods (usually reflow oven) to create a solder joint between PCB and the components on top, including the IC
- 3. Flux wash:** It is recommended to wash the PCB after soldering as flux residuals (even when using no-clean fluxes) may deteriorate the adhesion of the overmolding material. In case that an aggressive (water soluble flux) is used, washing will also remove the potential sources of corrosion.
- 4. Overmolding:** Thermoset or thermoplastic material is injected in the tooling cavity to partially or fully cover the assembly
- 5. Depanelling:** After overmolding, the panel is singulated according to the design (V-cut, milling or punching)

3. Overmolding of PCBA

PCB design for mold flow

Most gull wing packages have a non-zero stand-off, leaving a gap between the mold body and the surface of the PCB. Mold flow should be secured within this gap to avoid trapped air between the IC and the PCB which might lead to local stress. Therefore it is recommended to add a hole in the PCB just below the mold body for packages with non-zero stand-off. It is also recommended to add anchoring holes on the PCB between top and bottom mold to improve the adhesion:

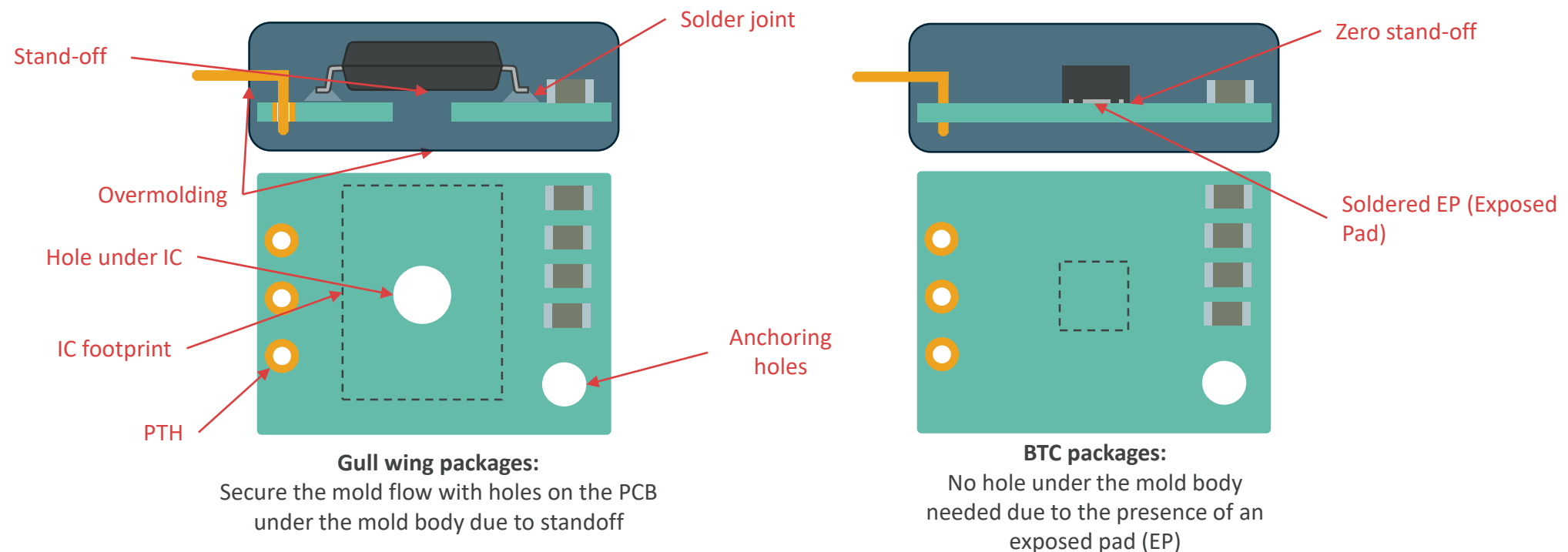

3. Overmolding of PCBA

Flux washing

During overmolding, solder flux residual on PCB surfaces will be trapped in the interface between the PCB and the mold material leading to decreased adhesion between the mold and the PCB as well as corrosion risk. Therefore it is recommended to always apply flux washing (even for NCH fluxes) to guarantee a clean surface without contaminants. Refer to *Guidelines for Surface Mount Technology (SMT) soldering* in Melexis website for more information.

3. Overmolding of PCBA

Known pitfall - PCB flexing

Flexing of the PCB during overmolding might lead to bending of the leadframe of the IC. This will create a stress on the IC which might develop a crack on the solder joint or the internal structure of the silicon die. Flexing of PCB during overmolding is typically due to:

1. Different mold thickness at top and bottom side of the PCB, leading to different flow
2. Mold design
3. Temperature exceeding the T_g (glass transition temperature) of the PCB itself

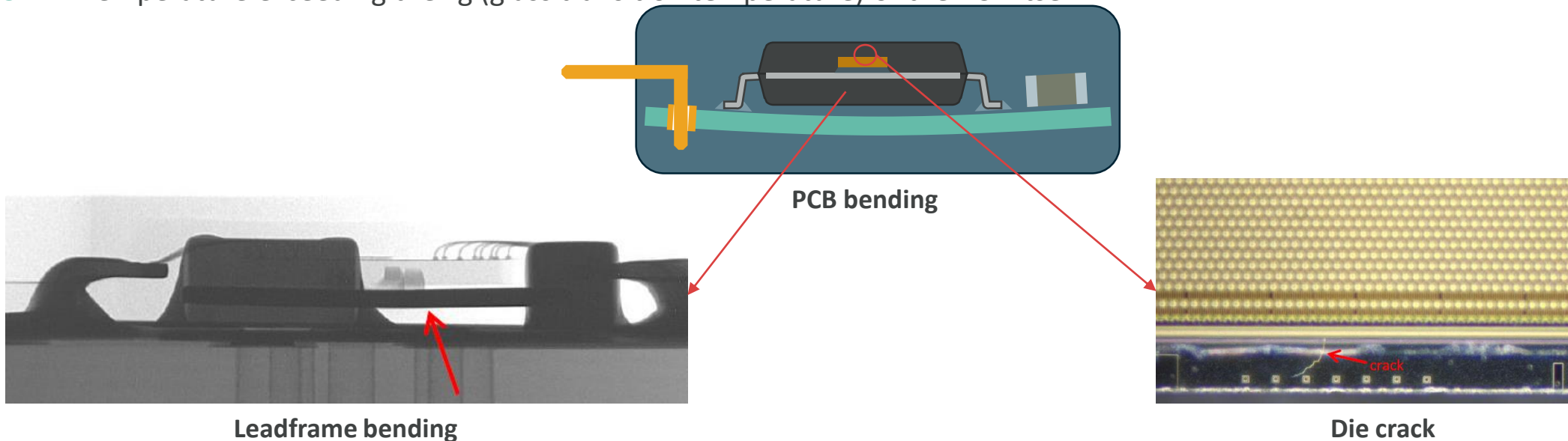

Annex I: List of Abbreviations

BGA: Ball Grid Array

BTC: Bottom Terminated Components

CTE: Coefficient of Thermal Expansion

DFN: Dual Flat No-Leads

DMP: Dual Mold Package

EP: Exposed Pad

GF: Glass Filler

HF: Halogen Free

IC: Integrated Circuit

NC: No clean

PA: Polyamide

PBT: Polybutylene Terephthalate

PCB: Printed Circuit Board

PCBA: Printed Circuit Board Assembly

PTH: Plated Through Hole

QFN: Quad Flat No-Leads

QFP: Quad Flat Package

SIP: Single Inline Package

SMD: Surface Mount Devices

SMP: Single Mold Package

SMT: Surface Mount Technology

SOIC: Small Outline Integrated Circuit

SOT: Small Outline Transistor

SSOP: Shrink-Small Outline Package

Tg: Glass Transition Temperature

TSSOP: Thin Shrink-Small Outline Package

UTDFN: Ultra Thin Dual Flat No-Leads

Annex II: List of Standards

J-STD-033: Handling, Packing, Shipping and Use of Moisture/Reflow Sensitive Surface Mount Devices

Annex III: List of Application Notes

For the latest revision of this document and related Application Notes, visit www.melexis.com/ic-handling-and-assembly

Guidelines for storage and handling of plastic encapsulated ICs

Guidelines for Surface Mount Technology (SMT) soldering



Melexis

INSPIRED ENGINEERING

The content of this document is believed to be correct and accurate. However, the content of this document is furnished "as is" for informational use only and no representation, nor warranty is provided by Melexis about its accuracy, nor about the results of its implementation. Melexis assumes no responsibility or liability for any errors or inaccuracies that may appear in this document. Customer will follow the practices contained in this document under its sole responsibility. This documentation is in fact provided without warranty, term, or condition of any kind, either implied or expressed, including but not limited to warranties of merchantability, satisfactory quality, non-infringement, and fitness for purpose. Melexis, its employees and agents and its affiliates' and their employees and agents will not be responsible for any loss, however arising, from the use of, or reliance on this document.

This document is subject to change without notice, and should not be construed as a commitment by Melexis. Therefore, before placing orders or prior to designing the product into a system, users or any third party should obtain the latest version of the relevant information.

Users or any third party must determine the suitability of the product described in this document for its application, including the level of reliability required and determine whether it is fit for a particular purpose.

This document as well as the product here described may be subject to export control regulations. Be aware that export might require a prior authorization from competent authorities. The product is not designed, authorized or warranted to be suitable in applications requiring extended temperature range and/or unusual environmental requirements. High reliability applications, such as medical life-support or life-sustaining equipment or avionics application are specifically excluded by Melexis. The product may not be used for the following applications subject to export control regulations: the development, production, processing, operation, maintenance, storage, recognition or proliferation of

1. chemical, biological or nuclear weapons, or for the development, production, maintenance or storage of missiles for such weapons;

2. civil firearms, including spare parts or ammunition for such arms;

3. defense related products, or other material for military use or for law enforcement;

4. any applications that, alone or in combination with other goods, substances or organisms could cause serious harm to persons or goods and that can be used as a means of violence in an armed conflict or any similar violent situation.

No license nor any other right or interest is granted to any of Melexis' or third party's intellectual property rights.

This disclaimer will be governed by and construed in accordance with Belgian law and any disputes relating to this disclaimer will be subject to the exclusive jurisdiction of the courts of Brussels, Belgium.

The invalidity or ineffectiveness of any of the provisions of this disclaimer does not affect the validity or effectiveness of the other provisions.

The previous versions of this document are repealed.

Melexis © - No part of this document may be reproduced without the prior written consent of Melexis. (2021)