



## **APPLICATION NOTE**

# Guidelines for lead forming of Hall sensors in Dual Mold Package (DMP)

Revision 1.0 – March 2022

Advanced Customer Solutions

# Guidelines for leadforming of Hall sensors in DMP package

1. Scope

2. Step sequence of lead forming process

2.1 Positioning

2.2 Clamping

2.3 Bending/cutting

3. Bending/cutting of pre-formed DMP long pins

4. Fine pitch DMP leads bending between mold bodies

5. DMP long pin spreading to a non-standard pitch

6. Post-forming inspection

# 1. Scope

## DMP extra leadforming at customer

Often Melexis customers require specific lead forming to match their subsystem design. Examples are shown below, other shapes may be possible as well. Contact Melexis to review your specific shape.

**The present document establishes major guidelines how to design DMP lead forming tool and process.**

Melexis offers to assist customer forming process validation and risk assessment.

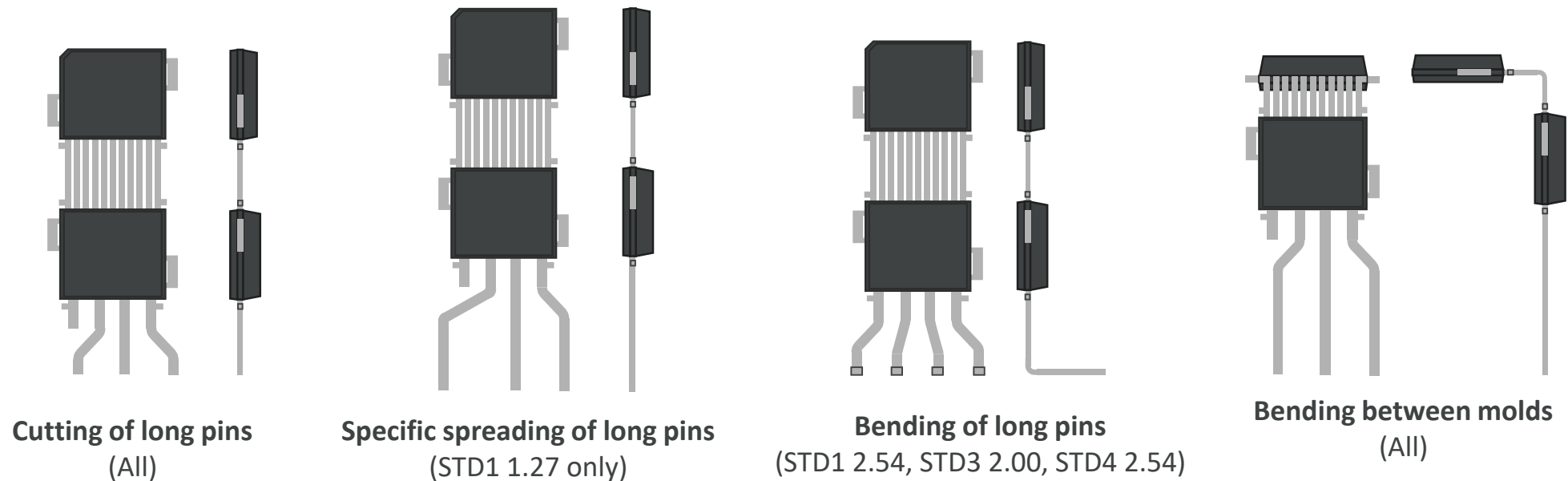

# 1. Scope

## DMP packages

By default, DMP package has 4 long straight leads with 1.27mm pitch. To accommodate welding electrodes (resistance welding) to housing terminals, customers might require more space between the leads. Therefore Melexis offers several standard DMP delivery forms pre-formed to 2.54 mm or 2.00 mm pitch at Melexis. They are described in the datasheet of every DMP Hall sensor and shown below.

NOT PRE-FORMED

PRE-FORMED AT MELEXIS

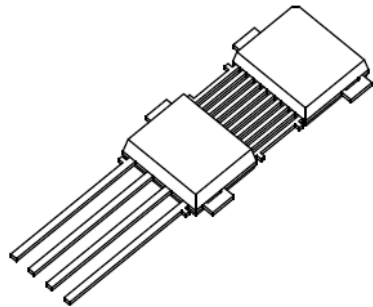

**STD1 1.27**  
Not pre-formed

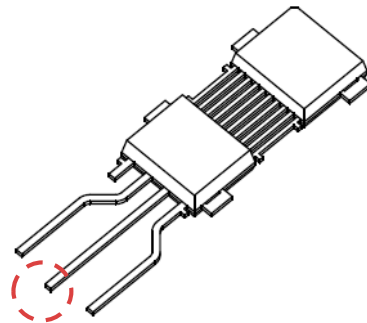

**STD1 2.54**  
Different pin length  
Not recommended for new designs

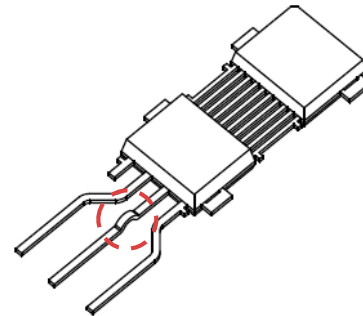

**STD2 2.54**  
With thermal relief  
Not recommended for leadforming at customer

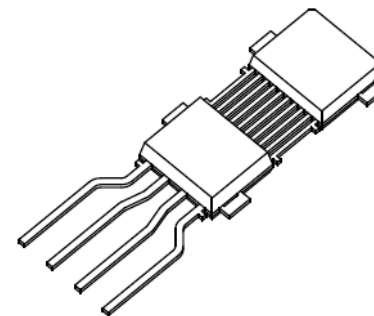

**STD3 2.00**  
Dual channel

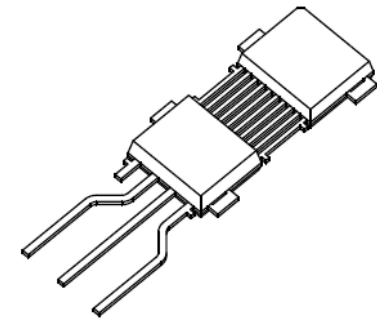

**STD4 2.54**  
Same pin length

# 1. Scope

## DMP taping specification

Dual mold Hall Sensor is delivered in a carrier tape-on-reel as specified in the product datasheet. For customer assembly, pick-up tool can be a standard round nozzle with a rubber tip. Melexis recommends second (middle) mold as a landing area for the pick-up head. It is best from a center of gravity perspective and also avoids risk of a mechanical stress applied on "on the mold containing the Hall element. **Maximum placement force should not exceed 3N.**

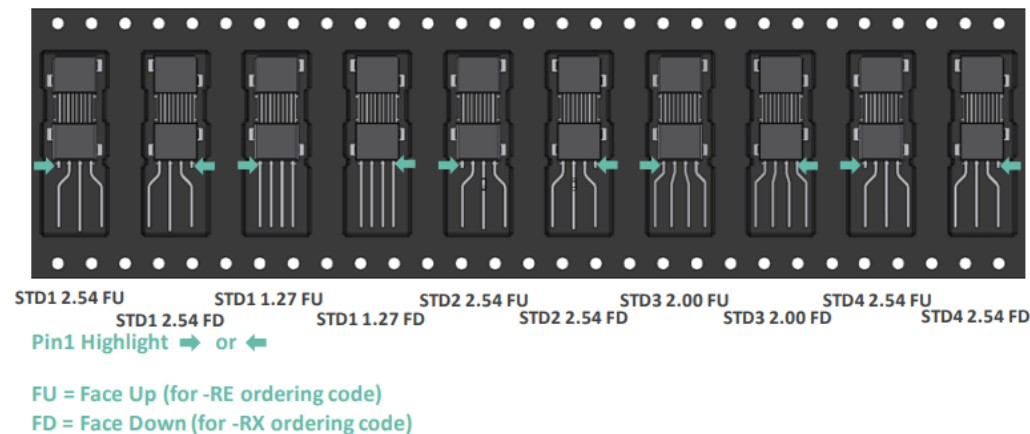

Note: Carrier tape is the same for all variants

Mold width: 5.20 mm

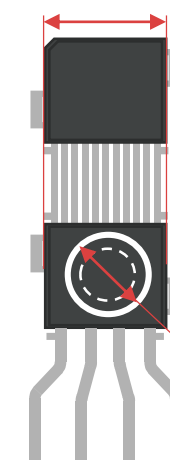

Nozzle OD:  
 From 2.00 to 4.70 mm

Example of circular nozzle for DMP

Storage and handling of Melexis devices at customer side should follow guidelines in J-STD-033 *Handling, Packing, Shipping and Use of Moisture/Reflow Sensitive Surface Mount Devices*. Key parameters are printed on the label attached to the product packing. Refer to *Guidelines for storage and handling of plastic encapsulated ICs* on Melexis website for details.

# Guidelines for leadforming of Hall sensors in DMP package

1. Scope

2. Step sequence of lead forming process

2.1 Positioning

2.2 Clamping

2.3 Bending/cutting

3. Bending/cutting of pre-formed DMP long pins

4. Fine pitch DMP leads bending between mold bodies

5. DMP long pin spreading to a non-standard pitch

6. Post-forming inspection

## 2. Step sequence of lead forming process

### Typical process flow for leadforming of DMP

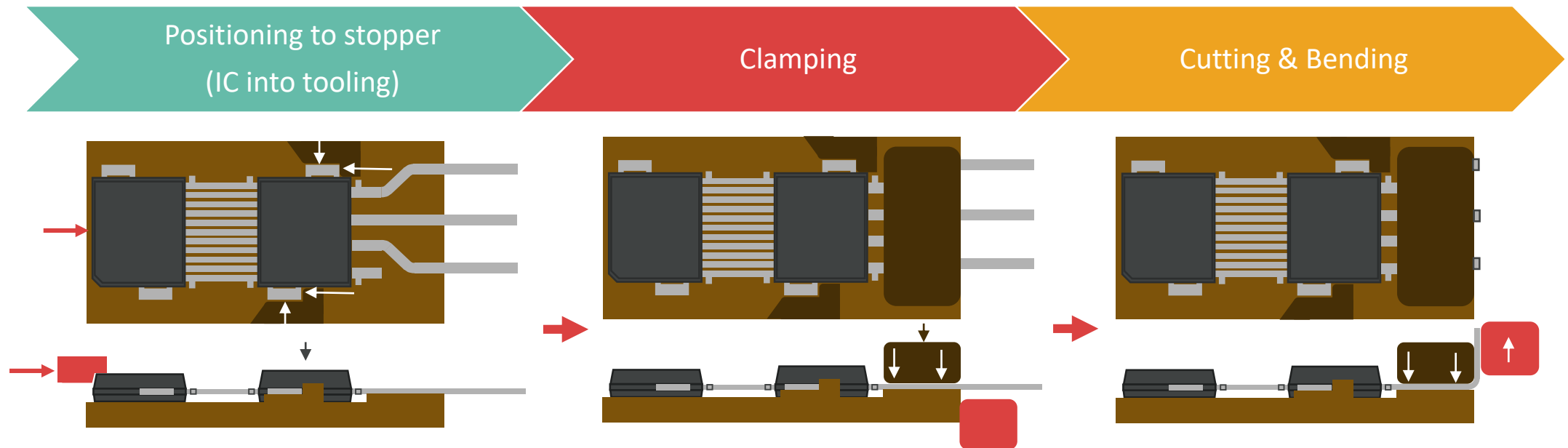

Leadforming of DMP is divided in three main steps:

1. Positioning on stopper: Using a pusher to position the DMP in X and Y stoppers accurately
2. Clamping: Anvils on top and bottom are fully closed before bending to avoid stress in the mold-lead interface
3. Cutting and bending: A cutting/bending anvil is used to shape the DMP to the desired leadframe

**Each step above shall start only after previous one is finished !**

# Guidelines for leadforming of Hall sensors in DMP package

1. Scope

2. Step sequence of lead forming process

2.1 Positioning

2.2 Clamping

2.3 Bending/cutting

3. Bending/cutting of pre-formed DMP long pins

4. Fine pitch DMP leads bending between mold bodies

5. DMP long pin spreading to a non-standard pitch

6. Post-forming inspection



## 2.1 Positioning

### DMP positioning features and clearance needed from tooling elements

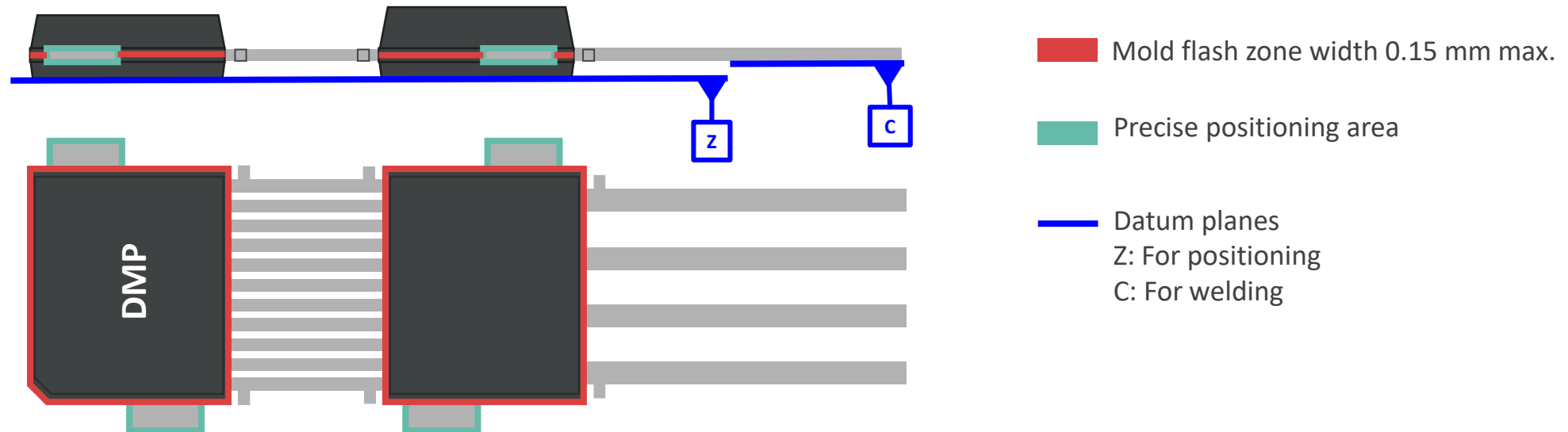

Mold flash and mold gate burr are inherent results of the molding process. They are mostly removed during mechanical de-flash process, but a minor leftover might still exist because of the clearance between the de-flash punch and the mold package. Refer to the POD (Package Outline Drawing) for all DMP package dimensions.

Contact Melexis for assistance in your actual tooling design, or for a risk assessment of the tooling performance, based on production samples inspection and analysis.

## 2.1 Positioning

### DMP positioning to stoppers into the lead forming tool

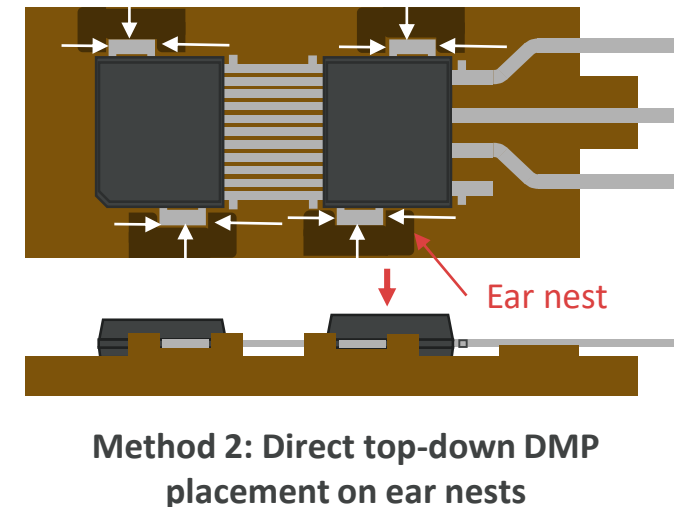
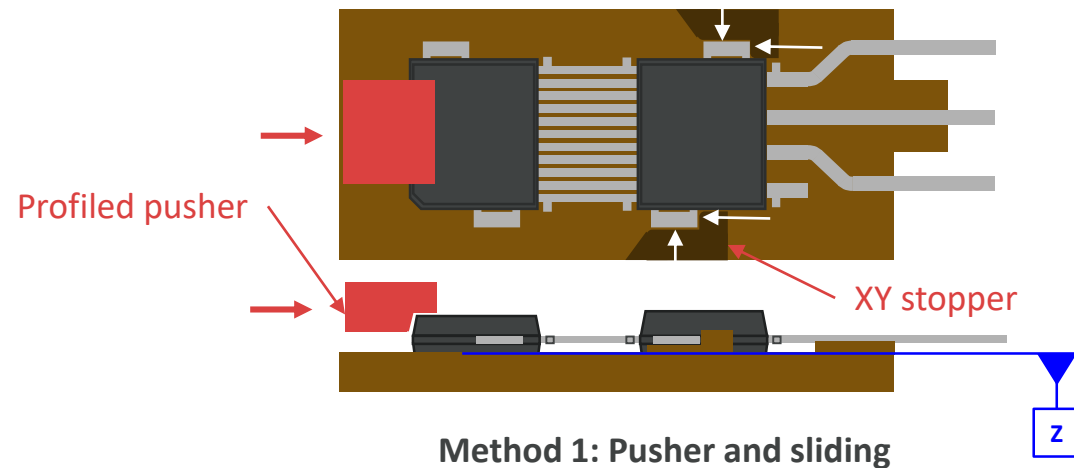

The role of positioning is to guarantee the repeatability of the bending/cutting line on DMP pins. The positioning process (Method 1):

- ☑ Place **mold bottom** on horizontal position (Z datum plane)
- ☑ A pusher force slides the DMP to X and Y **stoppers on ears** to guarantee accuracy of the cut/bend line on pins. It is recommended to use a profiled pusher to avoid contact with mold flash (only to top mold half) and avoid “lifting” effect
- ☑ **The pusher force shall stay applied until the clamping is fully closed (Z fixation)**

An alternative Method 2 to pusher and sliding is a direct top-down DMP placement on ear nests (it requires higher placement accuracy, but it does not need a pusher).

## 2.1 Positioning

### Design of stoppers on tabs(ears)

Enough clearance needs to be foreseen for possible mold flash in the ear corner – maximum 0.15mm from mold package

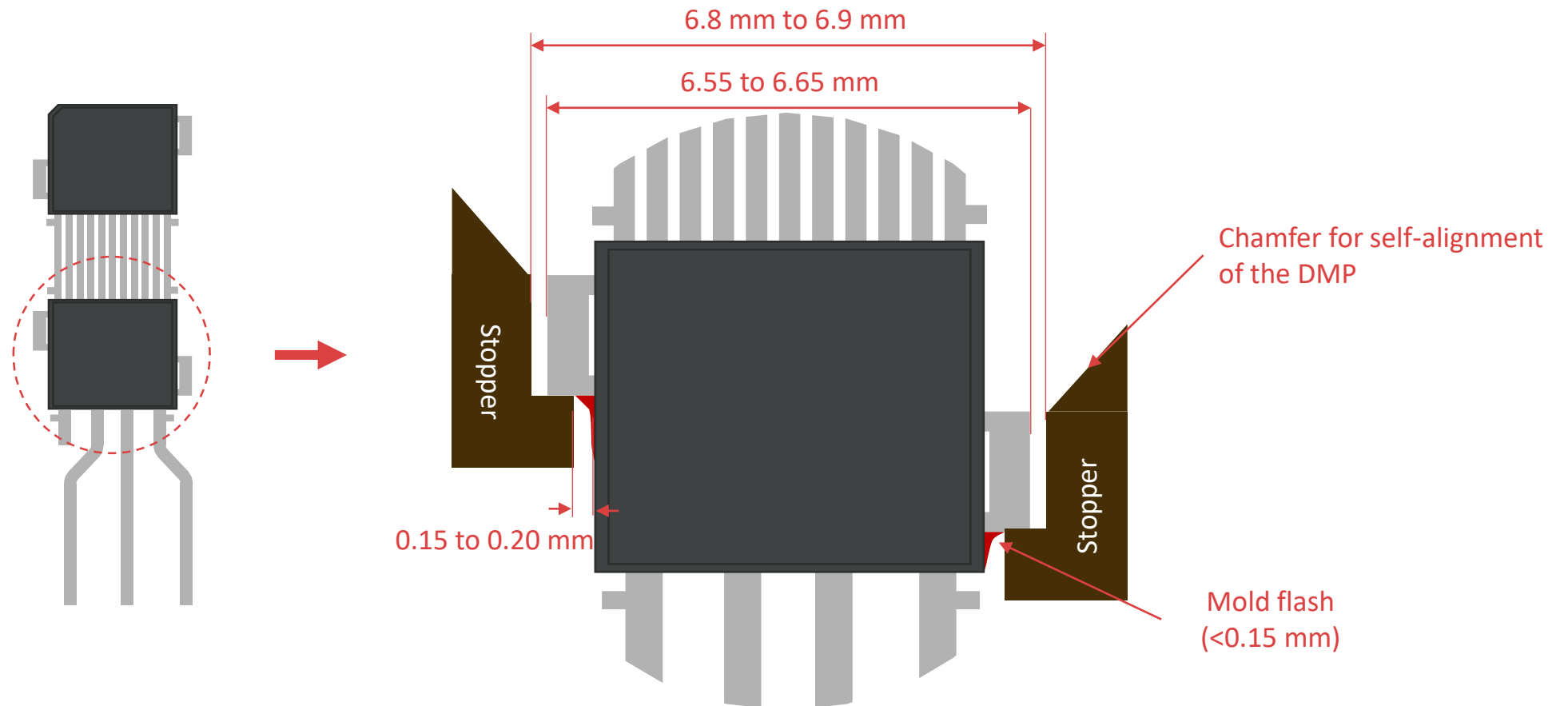

# Guidelines for leadforming of Hall sensors in DMP package

1. Scope

2. Step sequence of lead forming process

2.1 Positioning

2.2 Clamping

2.3 Bending/cutting

3. Bending/cutting of pre-formed DMP long pins

4. Fine pitch DMP leads bending between mold bodies

5. DMP long pin spreading to a non-standard pitch

6. Post-forming inspection

## 2.2 Clamping

### DMP lead clamping before cutting/bending

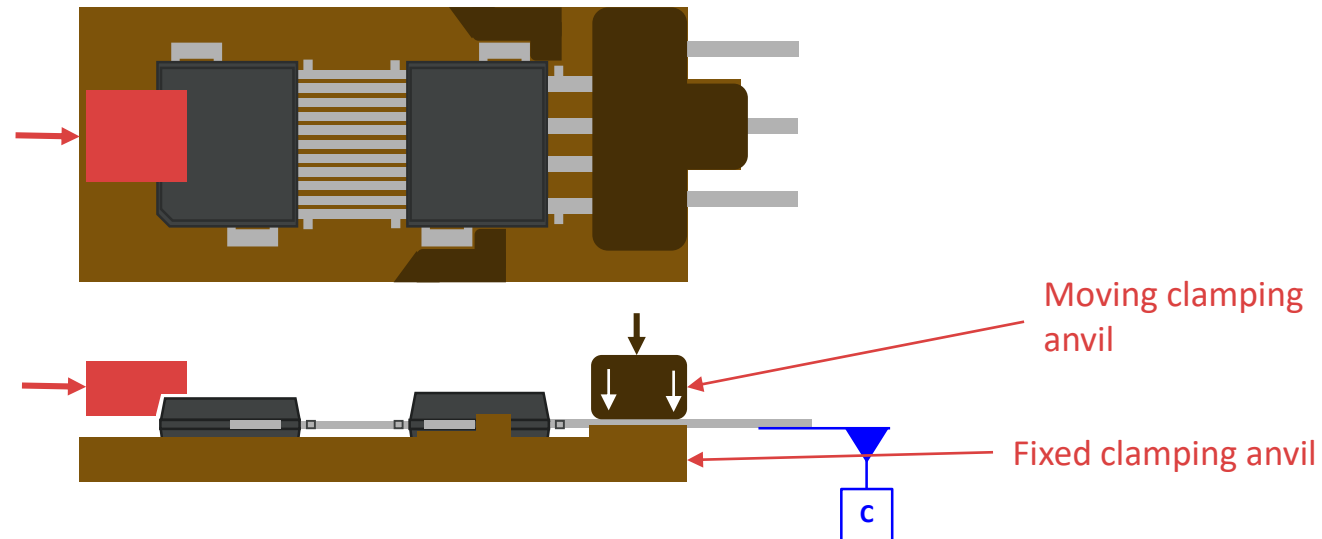

The role of clamping is to fix the DMP in position and prevent pin from mold pull/push force, provide counter support to bending anvil force and act as a inner bending anvil

- ✓ Fixed and moving clamping anvil edge defines bending (cutting) line
- ✓ Clamping shall be fully applied **BEFORE** starting of bend/cut action
- ✓ Clamping shall be released **AFTER** completion of bend/cut action
- ✓ Clamping force shall be approximately 3x of bend/cut force
- ✓ Clamping shall guarantee residual pull force on pins from mold is less than indicated values (sketch F pull)

## 2.2 Clamping

### Maximum pull forces allowed on mold-lead interface during bending action

Effective clamping on leads in designated area should be applied to prevent that a pull force is applied to the leads referenced to the mold body BEFORE and DURING bending or lead cutting operation. Maximum residual pull force on the mold-lead interfaces **after clamping**, produced by the bending anvil are shown in the following diagram. Exceeding these values may cause structural degradation and failure.

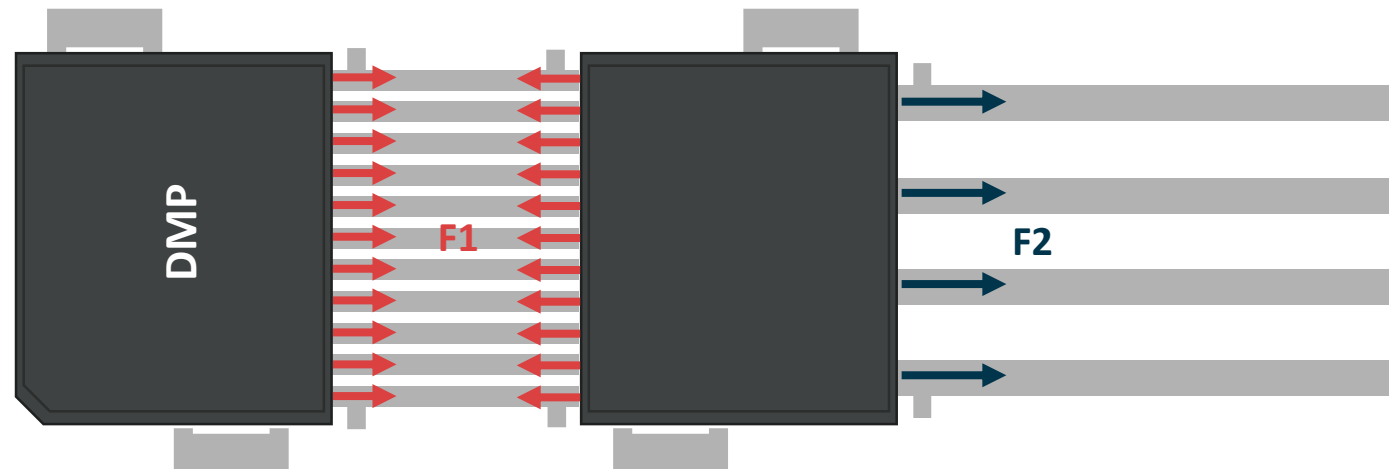

Pull force  $F1 < 1N$  (per fine pitch lead)

Pull force  $F2 < 3N$  (per lead)

(Tested as per IEC 60068-2-21 for 10s)

## 2.2 Clamping

### Restrictions on clamping

When bending or cutting a DMP, the following **minimum** areas should be followed to avoid mechanical damage to the IC. A minimum clamping area of 3.00mm in the long pins is recommended to avoid any conflict with the bends already present from Melexis preforming.

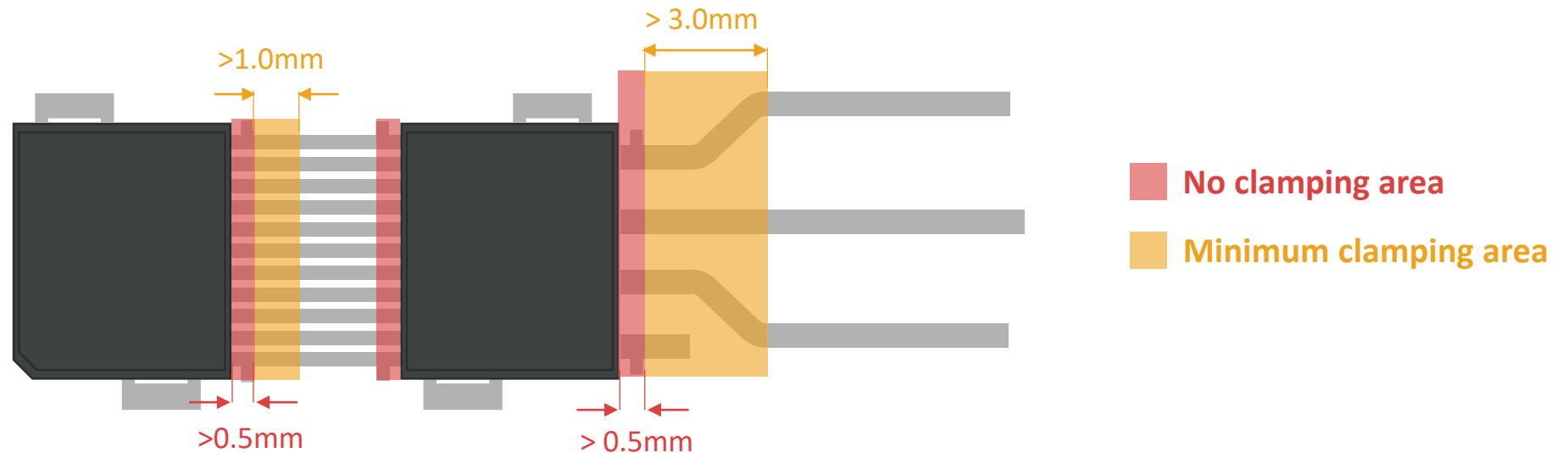

# Guidelines for leadforming of Hall sensors in DMP package

1. Scope

2. Step sequence of lead forming process

2.1 Positioning

2.2 Clamping

2.3 Bending/cutting

3. Bending/cutting of pre-formed DMP long pins

4. Fine pitch DMP leads bending between mold bodies

5. DMP long pin spreading to a non-standard pitch

6. Post-forming inspection



## 2.3 Bending/cutting

### DMP lead bend/cut step

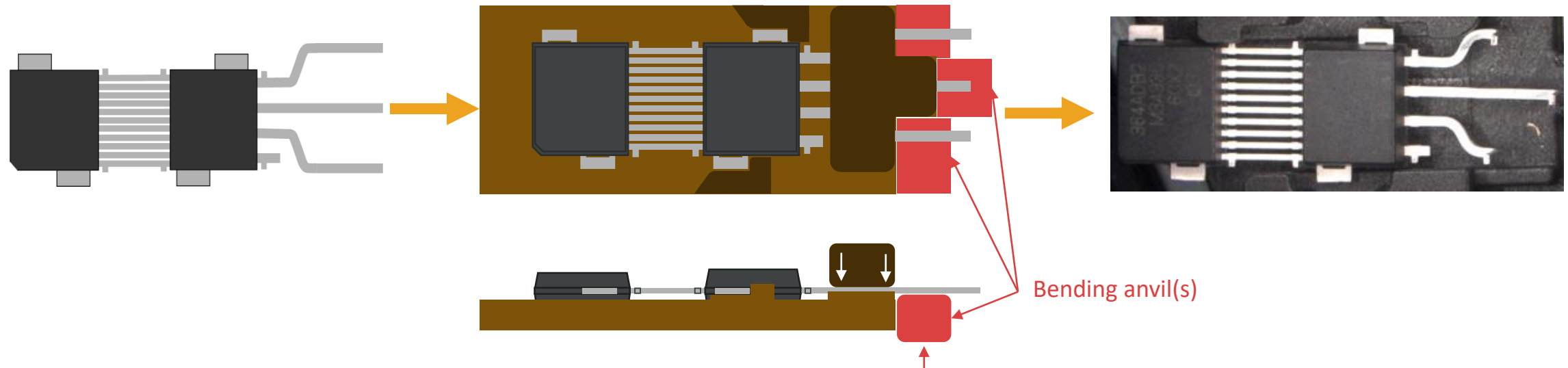

The role of bending and cutting is to achieve the desired lead shape and dimensions by moving the bending anvil versus the fixed clamping anvil. It should start after the clamping is fully effective

- ✔ **Bend:** It requires over-bending to compensate the pin spring-back and shall not scratch lead Sn plating,
- ✔ **Cut:** Cutting direction should be selected such so that resulting burr has no conflict with welding terminal. Keep the gap between cutting anvils to the required minimum

Cutting and bending tool details shown in the next slides

# Guidelines for leadforming of Hall sensors in DMP package

1. Scope

2. Step sequence of lead forming process

2.1 Positioning

2.2 Clamping

2.3 Bending/cutting

3. Bending/cutting of pre-formed DMP long pins

4. Fine pitch DMP leads bending between mold bodies

5. DMP long pin spreading to a non-standard pitch

6. Post-forming inspection

# 3. Bending/cutting of pre-formed DMP long pins

## Tooling details

Where possible, Melexis recommends applying roller bending to prevent lead surface damage. Polished anvil is also ok. To overcome the spring-back effect, an over-bending of 2° to 3° is recommended on top of the target bending angle. **Minimum bending radius should be 0.3mm**

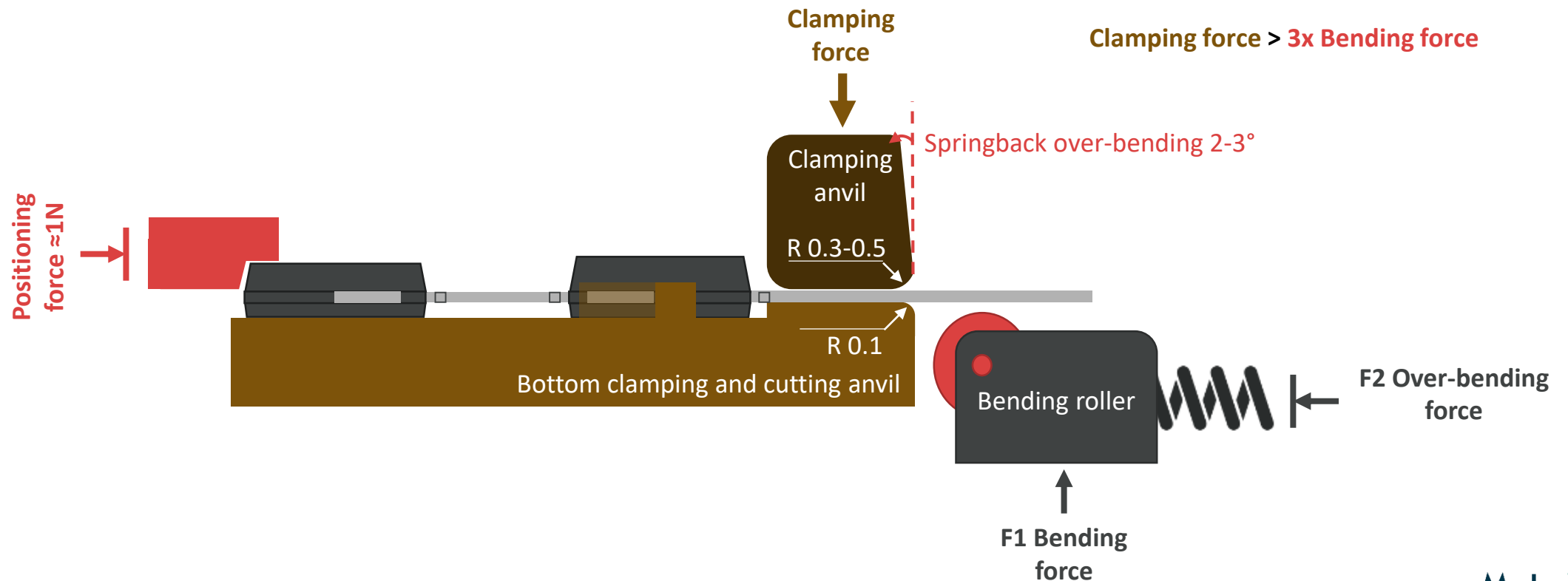

## 3. Bending/cutting of pre-formed DMP long pins

### Cutting tool details

For lead length trimming (cutting) effective clamping of leads next to the cutting line is also required. Same clamping rules and dimensions apply. **Cutting actions should begin after clamping is fully closed.**

The gap between cutting anvils should be kept within the limits shown. When the gap increases beyond these limits a large cutting burr may appear on the lead tip after cut. It may seriously affect positioning of the parts for soldering and welding and be a reason for poor connection.

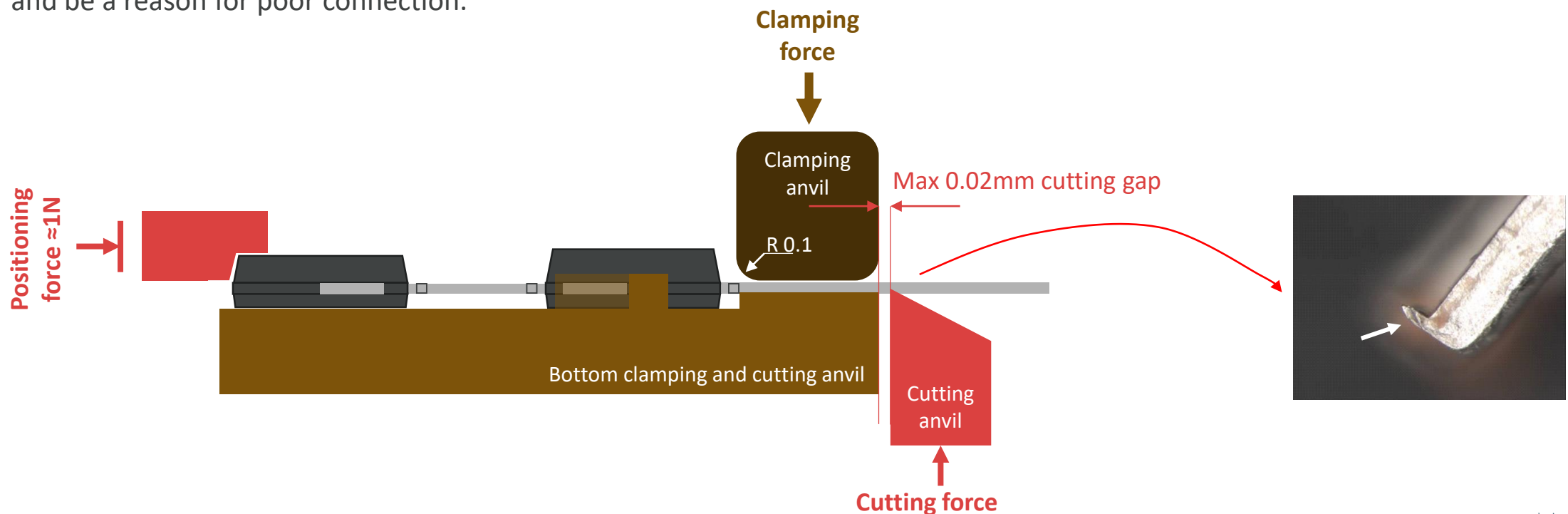

### 3. Bending/cutting of pre-formed DMP long pins

#### Impact of cutting burr during welding

If a cutting burr appears on the lead tip after cut, it might impact positioning of the lead on the leadframe (datum c). A large gap may impact welding joint strength due to the poor thermal contact between both metals. Therefore, cutting direction should be designed in such a way that the cutting burr is facing up after placement.

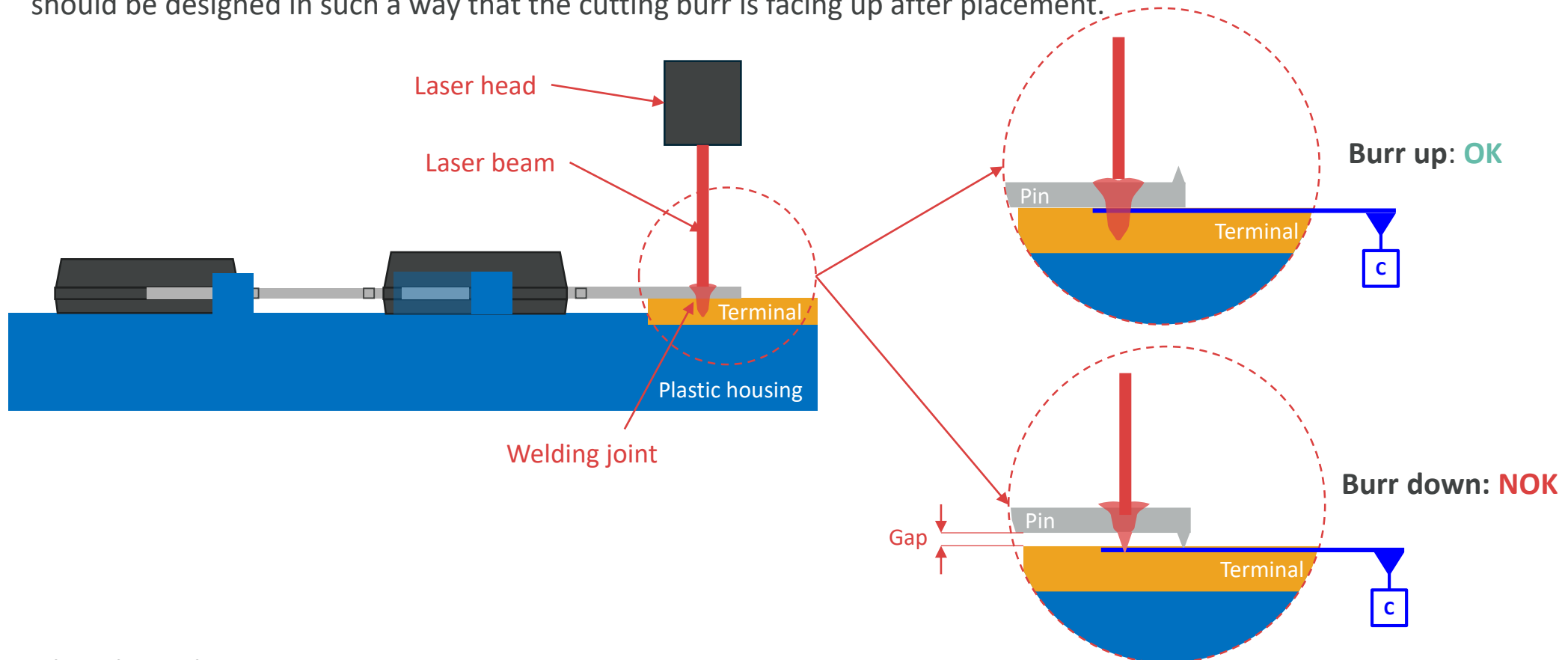

## 3. Bending/cutting of pre-formed DMP long pins

### STD2 2.54 Note

STD2 2.54 is not recommended for leadforming at customer due to two reasons

1. The bump (i.e. thermal relief) is limiting the clamping area
2. The bending applied during leadforming is playing the same role as the bump in terms of absorbing thermal elongations during thermal excursions.

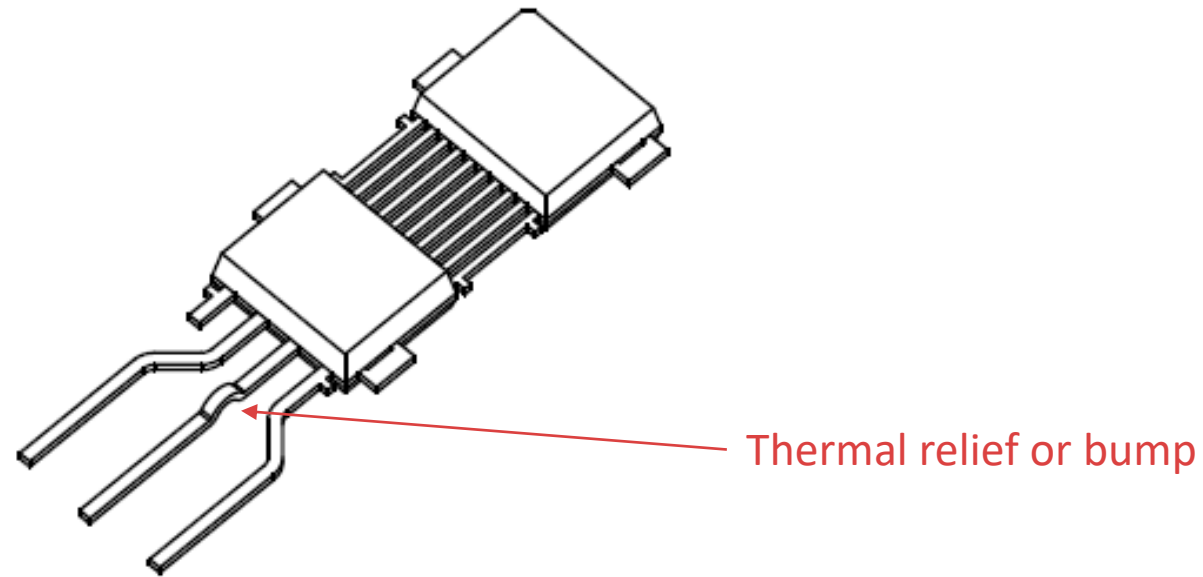

# Guidelines for leadforming of Hall sensors in DMP package

1. Scope

2. Step sequence of lead forming process

2.1 Positioning

2.2 Clamping

2.3 Bending/cutting

3. Bending/cutting of pre-formed DMP long pins

4. Fine pitch DMP leads bending between mold bodies

5. DMP long pin spreading to a non-standard pitch

6. Post-forming inspection

## 4. Fine pitch DMP leads bending between mold bodies

### Tooling design key points

DMP bending between mold blocks requires higher clamping and bending forces due to the large number of pins to be bent simultaneously.

Limited distance between molds (3.5mm) is challenging for the separation of clamping and bending zones

Bending anvil travel distance is short, so the **bending anvil/roller travel shall end before making a contact to the mold in order to prevent internal structure stress.**

Positioning by ears(tabs) is strongly recommended.

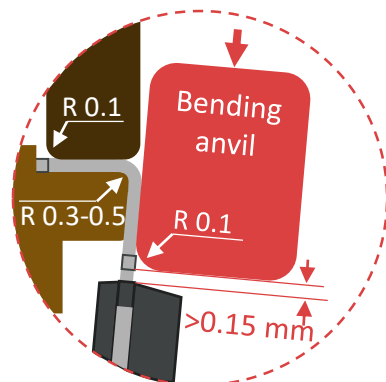

**Bending anvil**

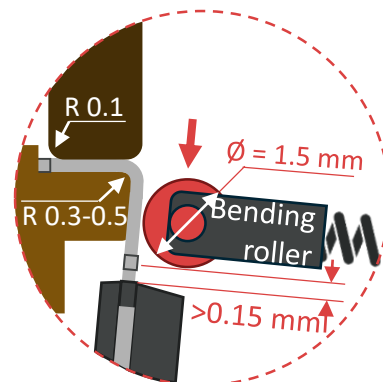

**Bending roller**

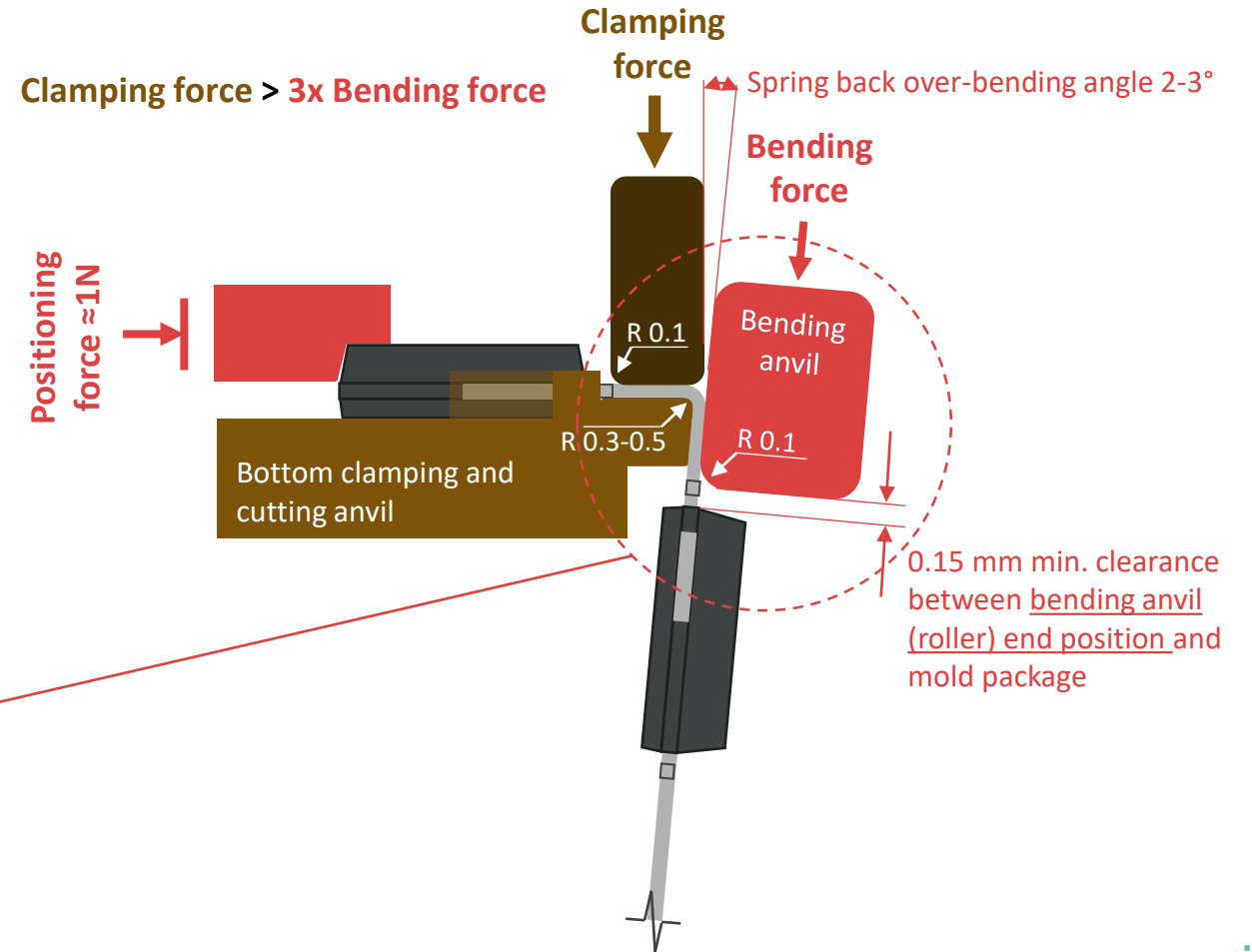



## 4. Fine pitch DMP leads bending between mold bodies

### Twisting of pins at the bending line

If the DMP XY position is not properly fixed by stoppers on ears prior bending, the bending line might twist. This might impact the position of the IC in the plastic housing as well as the alignment between the Hall plate and the magnetic target

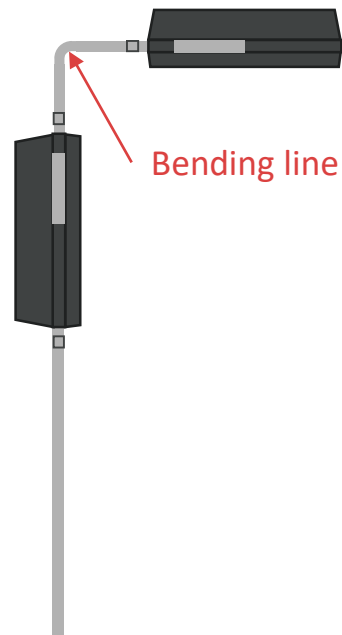

SIDE VIEW

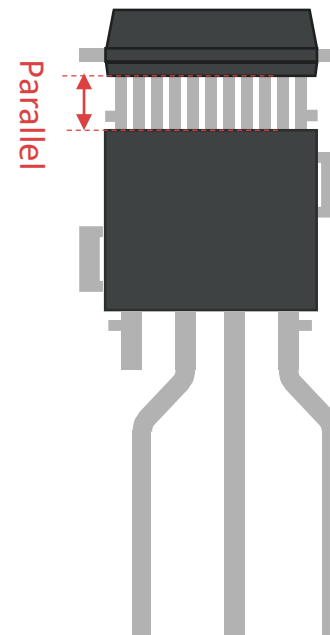

OK

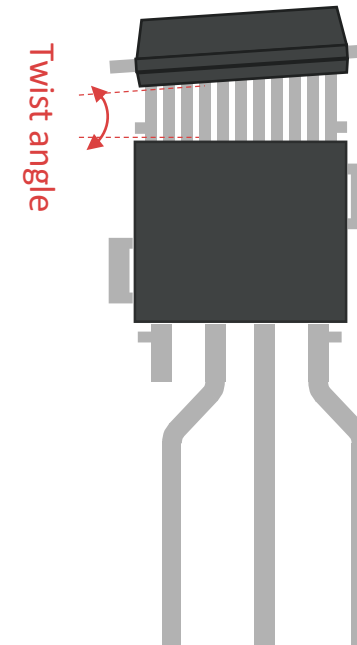

NOK

TOP VIEW

# Guidelines for leadforming of Hall sensors in DMP package

1. Scope

2. Step sequence of lead forming process

2.1 Positioning

2.2 Clamping

2.3 Bending/cutting

3. Bending/cutting of pre-formed DMP long pins

4. Fine pitch DMP leads bending between mold bodies

5. DMP long pin spreading to a non-standard pitch

6. Post-forming inspection

## 5. DMP long pin spreading to a non-standard pitch

### Dimensions during spreading

Sometimes asymmetrical pitches or pitches not offered by Melexis (2.00 and 2.54 mm) are required to match the plastic housing terminals (leadframe). For this purpose, STD1 1.27 can be used. When 3 pin final configuration is required, pin 1 should be cut short before spreading pin 2 and 4.

Recommended minimum bending radius and bending angle for spreading are given below:

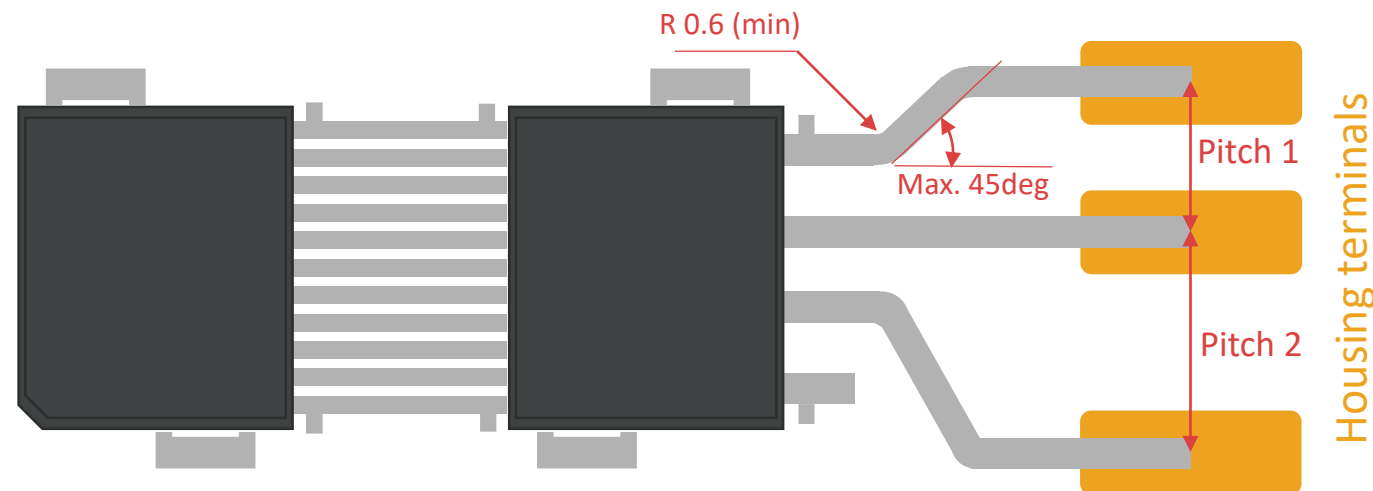

# 5. DMP long pin spreading to a non-standard pitch

## Stoppers on dambar wings

Stopper on dambar wings is **only applicable for STD1 1.27** devices for lead pitch spreading. Position the DMP by a soft pusher on mold body against dambar wings. Dambar wings are specific extensions of 0.3mm on outer leads to be used for stoppers and side pin support during spreading.

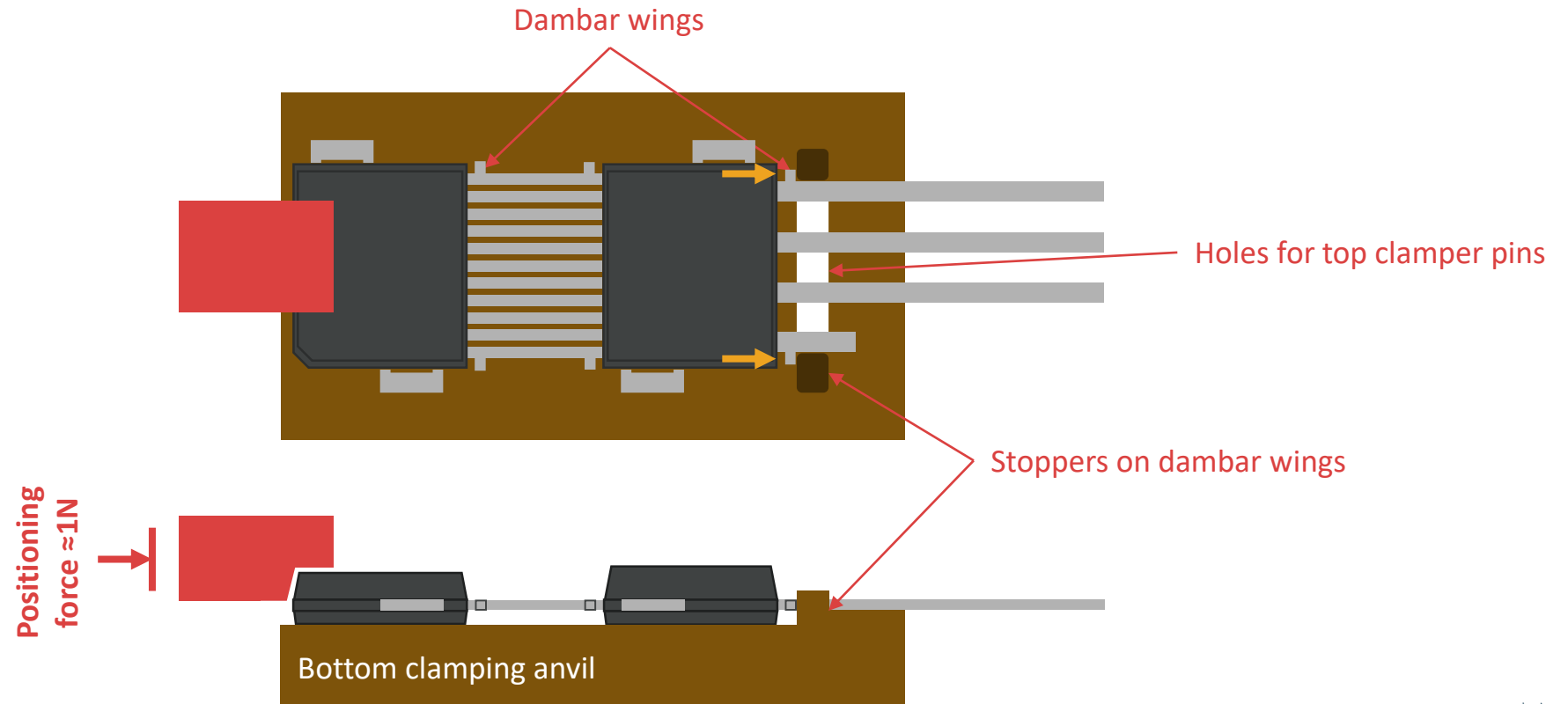

# 5. DMP long pin spreading to a non-standard pitch

## Design of stoppers on dambar wings

Rounded edges of the stopper block needs to be foreshen to accommodate the dambar wings radius

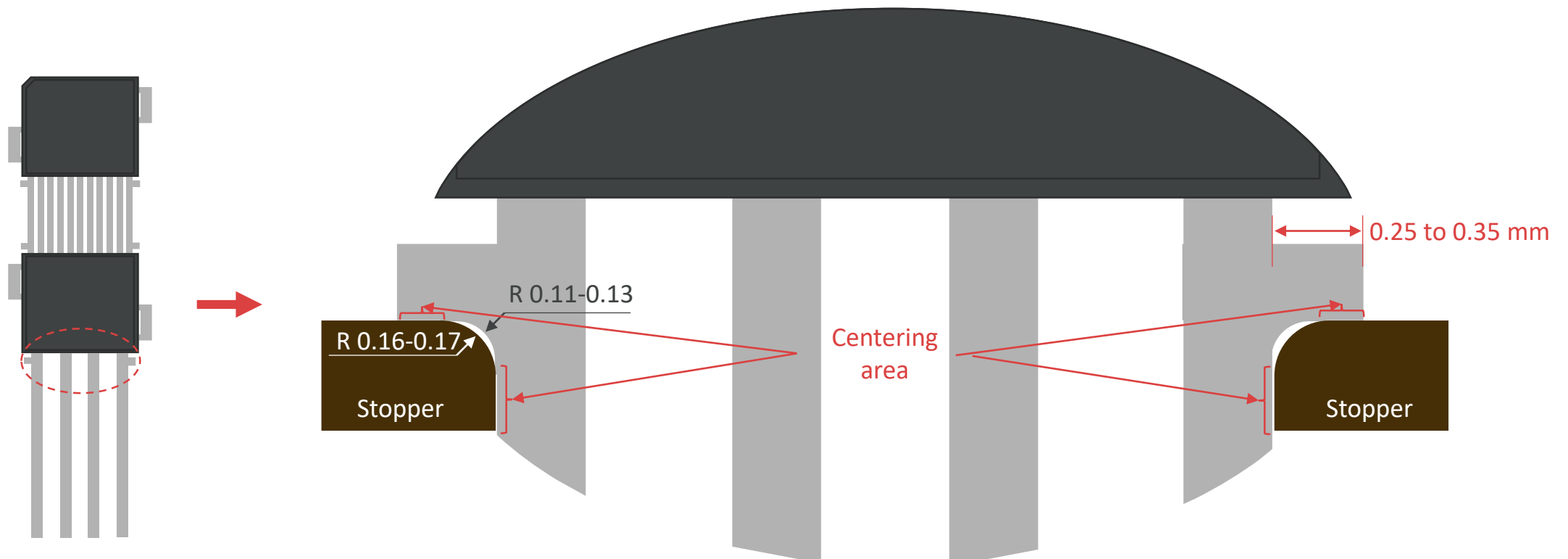

# 5. DMP long pin spreading to a non-standard pitch

## Positioning of IC in tooling

Stoppers on dambar wings are a must since they help maintain the pin in place during spreading. The side supports define the final shape of the formed leads. These side supports also define the resting plane for the top clamping anvil.

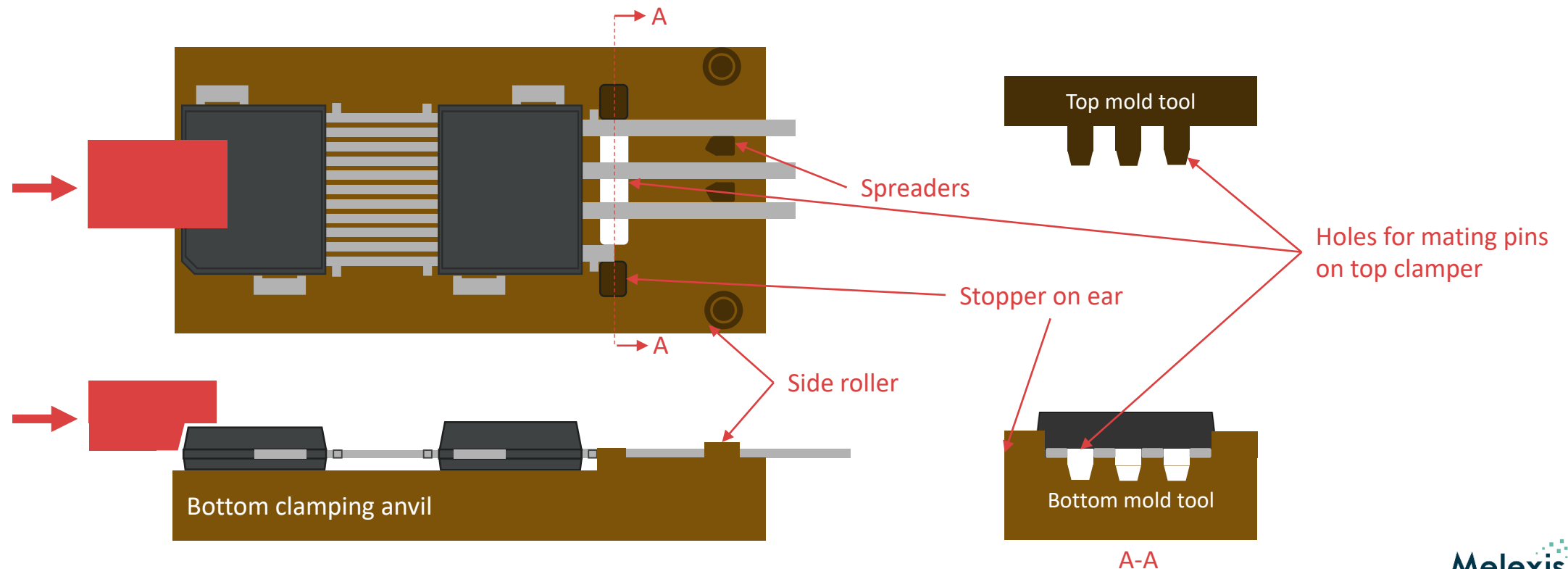

# 5. DMP long pin spreading to a non-standard pitch

## Lead spreading

The top clamping anvil has pins mating the holes of the bottom one. These pins act as side stopper to the leads during the bending action. A clearance between the top clamping anvil and the leads of 0.05-0.1mm should be maintained to prevent Z-bending during spreading.

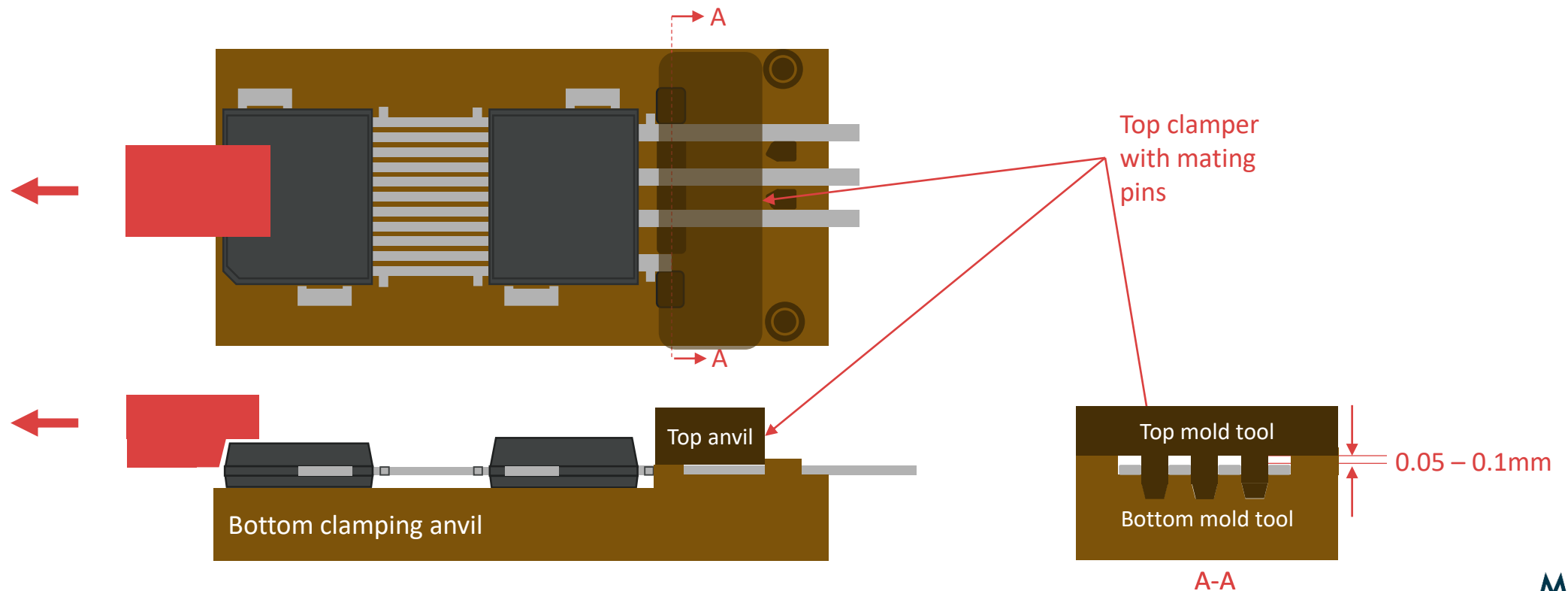

# 5. DMP long pin spreading to a non-standard pitch

## Tooling details

Stoppers on dambar wings are a must since they help maintain the pin in place during spreading. Clamping is split in two:

- Top clamber with pins mating to the holes of the bottom one. Restriction from top with 0.05-0.1mm clearance from leads to prevent Z-bending during spreading
- Support from the side of the spread pins

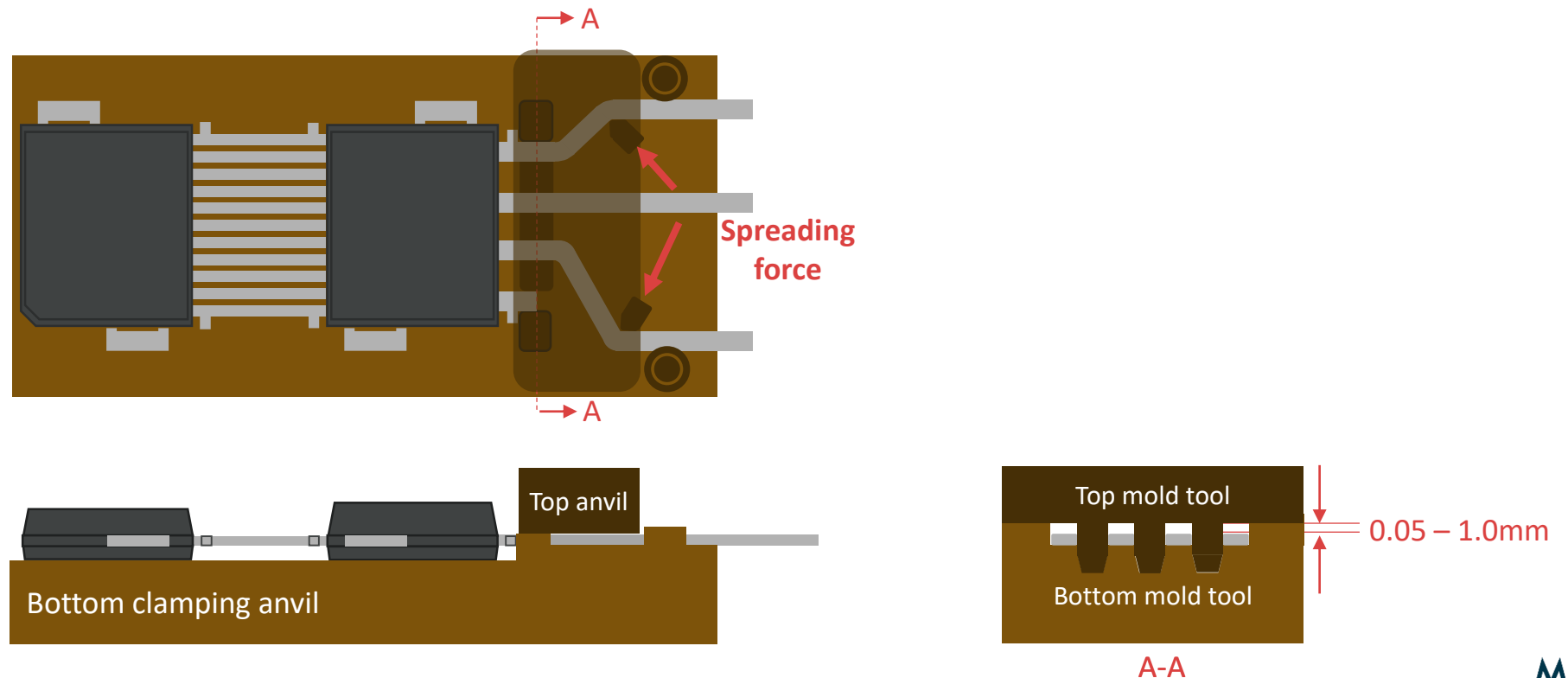



# Guidelines for leadforming of Hall sensors in DMP package

1. Scope

2. Step sequence of lead forming process

2.1 Positioning

2.2 Clamping

2.3 Bending/cutting

3. Bending/cutting of pre-formed DMP long pins

4. Fine pitch DMP leads bending between mold bodies

5. DMP long pin spreading to a non-standard pitch

6. Post-forming inspection

## 6. Post-forming inspection

### Inspection items

The items checked during post-forming inspection depends on whether the project is in PV (process validation) or MP (Mass Production). The following is a suggested list of inspection items per project status.

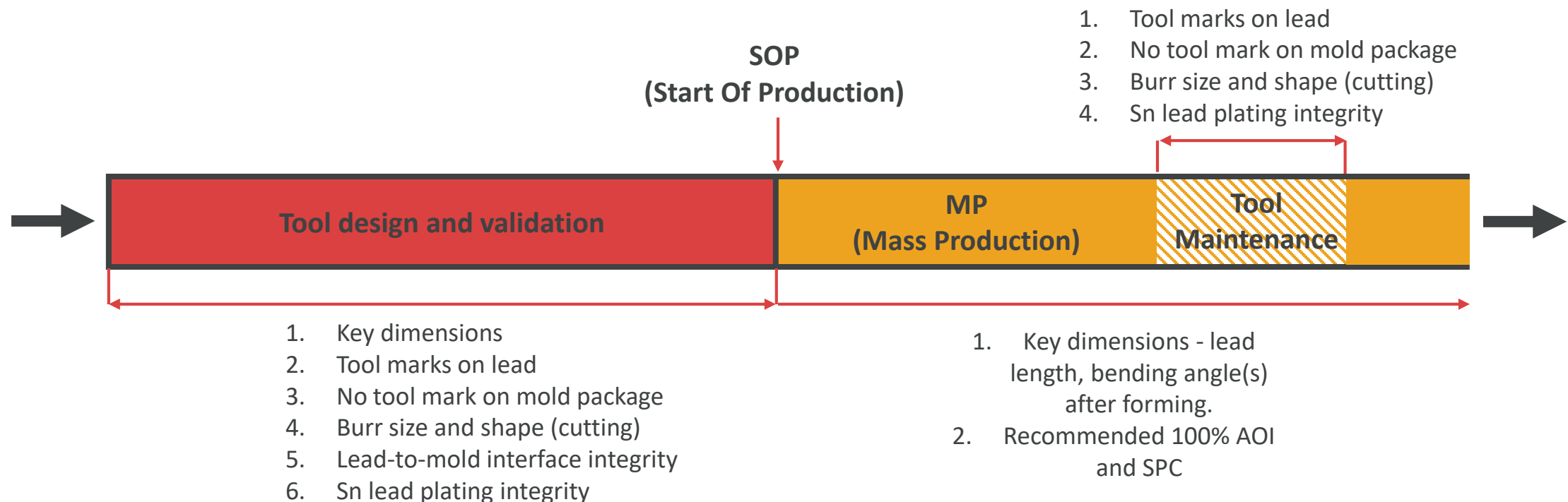

## 6. Post-forming inspection

### Key dimensions SPC tracked during mass production - examples

Key dimensions control is suggested during PV - lead length, bending angle, bending radius. During MP, it is recommended to perform 100% AOI and SPC on both Lead length, bending angle.

Dambar wings and ears (positioning stoppers) shall be used as datum planes for the measurements of lead length

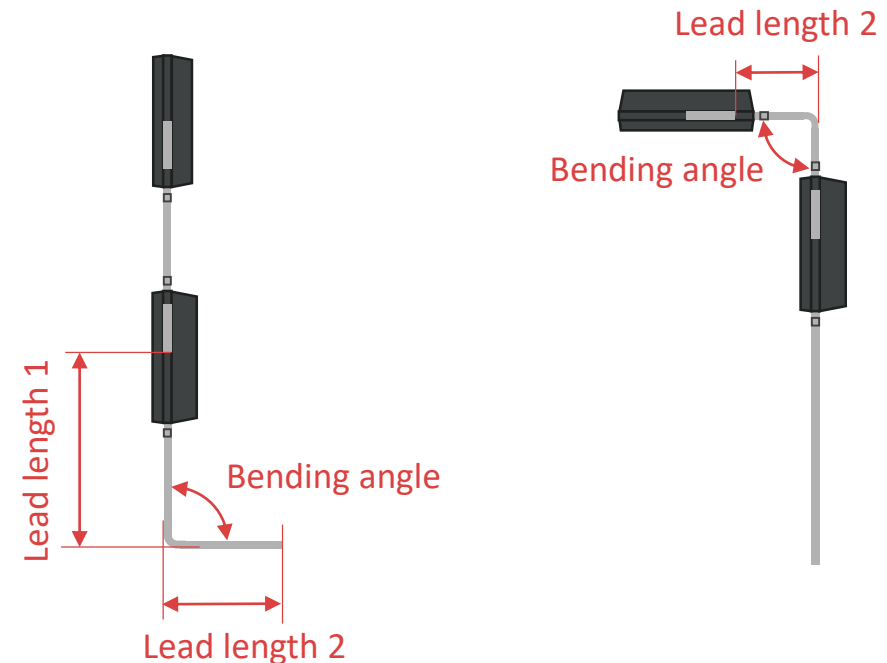
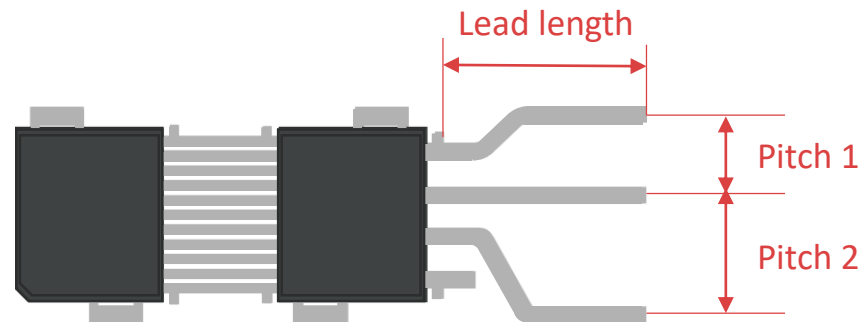

## 6. Post-forming inspection

### Tool marks on leads – 100% during PV, sample based during MP

Tool marks on leads can be used as a process validation criteria. A thorough inspection for consistent tool marks on lead and mold package should be implemented during tool validation and initial production.

**Inconsistent marks may indicate twisting of mold packages in reference to each other with a risk of internal structural damage**

**Inconsistent = Systematically different by length/width/depth tool marks on different pins**

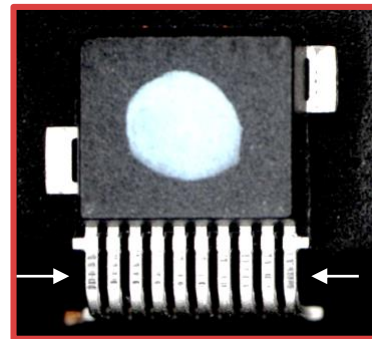
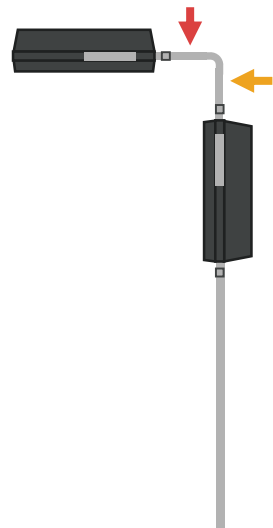

Clamping marks - **OK**

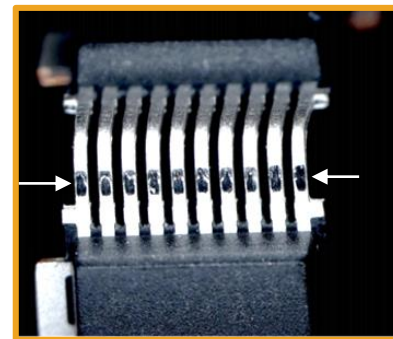

Bending anvil marks - **OK**

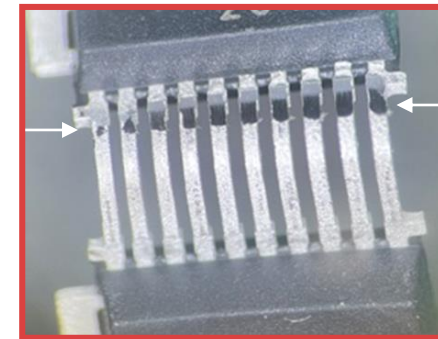

Bending anvil marks - **NOK**

Example - bending between mold bodies

## 6. Post-forming inspection

### Lead-to-mold interface integrity – during process validation

The lead-to-mold interface integrity can be checked by inspection for pull overstress of leads from mold package.

Sliding marks indicate that clamping force is not enough and a high pull force is applied to lead and body. Insufficient clamping and resulting pull force on leads from the mold body may create delamination, microcracks and wire bond damage.

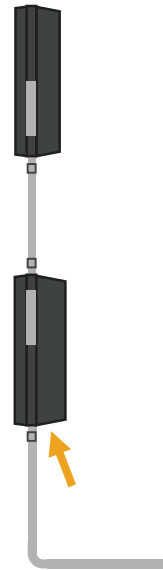

**Delamination of pin from mold (exposed copper) due to insufficient clamping (SEM)**

# Annex I: List of Abbreviations

**AOI:** Automatic Optical Inspection

**DMP:** Dual Mold Package

**ERW:** Electrical Resistance Welding

**FU:** Face Up

**FD:** Face Down

**IC:** Integrated Circuit

**MP:** Mass Production

**OD:** Outer Diameter

**OM:** Optical Microscopy

**PCB:** Printed Circuit Board

**POD:** Package Outline Drawing

**PV:** Process Validation

**SEM:** Scanning Electron Microscope

**SOP:** Start Of Production

**SPC:** Statistical Process Control

**STD:** Standard

# Annex II: List of Standards

*J-STD-033 Handling, Packing, Shipping and Use of Moisture/Reflow Sensitive Surface Mount Devices*

*IEC 60068-2-1 Robustness of terminations and integral mounting devices*



# Annex III: List of Related Application Notes

*For the latest revision of this document and related Application Notes, visit [www.melexis.com/ic-handling-and-assembly](http://www.melexis.com/ic-handling-and-assembly)*

*Guidelines for storage and handling of plastic encapsulated ICs*

*Guidelines for leadforming of SIP Hall sensors*